

19

**rodamientos
y
cojinetes**

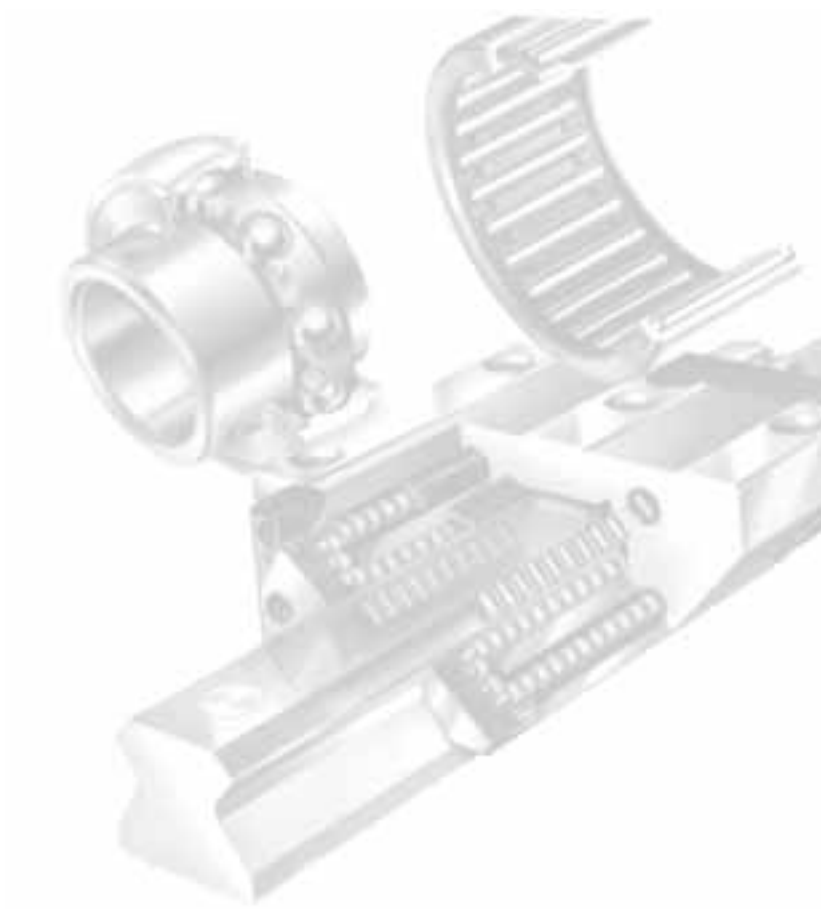

19001

CASQUILLOS DE BRONCE SINTERIZADO AUTOLUBRICADO

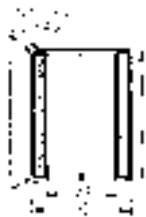

19001A...
Cilíndricos

- Su estructura porosa, permite una impregnación de aceite de alto poder lubricante, creándose una auténtica **película de aceite** eliminando el agarrotamiento, sin gripado, con un bajo coeficiente de rozamiento ● El sistema autolubricado resuelve todos los problemas de fricción, con un **funcionamiento silencioso** dentro de los siguientes límites: **Carga:** de 0 a 450 kg/cm²; **Velocidad:** de 0 a 30000 rpm (6m/seg.) **Temperatura:** -20° a 100° ● Eliminan todo tipo de entretenimiento ● Hacen innecesarios los engrasadores ● Fabricación sin arranque de viruta.

Tolerancias: d = G7
D = s7
L = j13

Excentricidad: Ø interior hasta 35 m 70µm.
35 hasta 50 mm 100µm

d mm	D mm	L mm
2	5	2
2	5	3
3	6	4
3	6	5
3	6	6
3	6	10
4	6	5
4	6	8
4	6	10
4	7	4
4	7	8
4	7	12
4	8	4
4	8	5
4	8	6
4	8	8
4	8	10
4	8	12
5	8	5
5	8	8
5	8	10
5	8	12
5	8	15
5	8	16
5	9	4
5	9	5
5	9	8
5	10	5
5	10	6
5	10	8
5	10	10
5	10	12
5	10	15
6	9	4
6	9	6
6	9	10
6	9	12
6	9	16
6	10	4
6	10	5
6	10	6
6	10	10
6	10	12
6	10	15
6	10	16
6	12	5
6	12	6
6	12	8
6	12	10
6	12	12

d mm	D mm	L mm
6	12	15
6	12	16
7	10	5
7	10	8
7	10	10
8	10	6
8	10	10
8	10	15
8	11	6
8	11	8
8	11	12
8	11	16
8	11	20
8	12	6
8	12	8
8	12	10
8	12	12
8	12	15
8	12	16
8	12	20
8	14	8
8	14	10
8	14	12
8	14	15
8	14	16
8	14	20
9	12	6
9	12	10
9	12	14
9	14	10
9	14	12
9	14	15
9	14	20
10	13	10
10	13	12
10	13	15
10	13	16
10	13	20
10	13	25
10	14	8
10	14	10
10	14	16
10	14	20
10	14	25
10	15	10
10	15	12
10	15	15
10	15	16
10	15	20
10	15	25

d mm	D mm	L mm
10	16	8
10	16	10
10	16	12
10	16	15
10	16	16
10	16	20
10	16	25
10	18	10
10	18	12
10	18	15
10	18	20
10	18	25
12	14	10
12	14	12
12	14	15
12	14	20
12	15	10
12	15	12
12	15	15
12	15	16
12	15	20
12	15	25
12	16	8
12	16	10
12	16	12
12	16	15
12	16	16
12	16	20
12	16	25
12	17	12
12	17	15
12	17	16
12	17	20
12	17	25
12	18	8
12	18	10
12	18	12
12	18	15
12	18	16
12	18	20
12	18	25
12	18	30
12	20	12
12	20	15
12	20	20
12	20	25
12	20	30
14	18	10
14	18	14
14	18	15

d mm	D mm	L mm
14	18	18
14	18	20
14	18	22
14	18	25
14	18	28
14	20	10
14	20	12
14	20	14
14	20	15
14	20	18
14	20	20
14	20	22
14	20	25
14	20	28
14	20	30
14	22	15
14	22	20
14	22	25
14	22	30
15	18	15
15	18	20
15	18	25
15	18	30
15	19	10
15	19	15
15	19	16
15	19	20
15	19	25
15	19	32
15	20	10
15	20	12
15	20	15
15	20	20
15	20	25
15	20	30
15	21	10
15	21	15
15	21	16
15	21	20
15	21	25
15	21	32
15	22	15
15	22	16
15	22	20
15	22	25
15	22	30
16	20	12
16	20	15
16	20	16
16	20	20

Casquillos de bronce sinterizado autolubricado

d mm	D mm	L mm
16	20	25
16	20	30
16	20	32
16	22	12
16	22	15
16	22	16
16	22	20
16	22	25
16	22	30
16	22	32
16	22	35
17	22	15
17	22	20
17	22	25
17	22	30
17	22	35
18	22	12
18	22	15
18	22	18
18	22	20
18	22	22
18	22	22
18	22	25
18	22	28
18	22	30
18	22	36
18	24	12
18	24	18
18	24	22
18	24	28
18	24	30
18	24	36
18	25	16
18	25	18
18	25	20
18	25	22
18	25	25
18	25	28
18	25	30
18	25	35
18	25	36
20	24	16
20	24	20
20	24	25
20	24	32
20	25	15
20	25	16
20	25	20
20	25	25
20	25	30
20	25	32
20	25	35
20	26	15
20	26	16
20	26	20
20	26	25
20	26	30
20	26	32
20	26	35
20	26	40
20	27	16
20	27	20
20	27	25
20	27	32
20	28	16
20	28	20
20	28	25
20	28	30
20	28	32

d mm	D mm	L mm
20	28	35
20	28	40
20	30	20
20	30	25
20	30	30
20	30	35
20	30	40
22	27	15
22	27	18
22	27	20
22	27	22
22	27	25
22	27	28
22	27	30
22	27	35
22	27	36
22	27	40
22	28	18
22	28	20
22	28	22
22	28	25
22	28	28
22	28	30
22	28	35
22	28	36
22	28	40
22	29	18
22	29	22
22	29	28
22	29	36
25	30	20
25	30	25
25	30	30
25	30	32
25	30	35
25	30	40
25	32	20
25	32	25
25	32	30
25	32	32
25	32	35
25	32	40
25	32	45
25	35	25
25	35	30
25	35	35
25	35	40
25	35	45
25	35	50
28	32	20
28	32	22
28	32	25
28	32	28
28	32	32
28	32	36
28	32	40
28	33	20
28	33	22
28	33	25
28	33	28
28	33	32
28	33	36
28	33	40
28	33	45
28	35	25
28	35	30
28	35	35
28	35	40

d mm	D mm	L mm
28	35	45
28	35	50
28	36	22
28	36	28
28	36	36
28	36	45
30	35	20
30	35	25
30	35	30
30	35	35
30	35	40
30	35	45
30	35	50
30	38	20
30	38	24
30	38	25
30	38	30
30	38	35
30	38	38
30	38	40
30	38	45
30	38	50
30	40	20
30	40	25
30	40	30
30	40	35
30	40	40
30	40	45
30	40	50
32	38	20
32	38	25
32	38	32
32	38	40
32	38	50
32	40	20
32	40	25
32	40	30
32	40	32
32	40	35
32	40	40
32	40	45
32	40	50
35	40	20
35	40	25
35	40	30
35	40	35
35	40	40
35	40	45
35	40	50
35	41	25
35	41	35
35	41	40
35	44	22
35	44	28
35	44	35
35	45	25
35	45	30
35	45	35
35	45	40
35	45	45
35	45	50
35	45	60
36	42	22
36	42	28
36	42	36
36	42	45
36	45	22
36	45	28

d mm	D mm	L mm
36	45	36
36	45	45
38	44	25
38	44	35
38	44	45
40	45	35
40	45	40
40	45	45
40	45	50
40	46	25
40	46	30
40	46	32
40	46	40
40	46	50
40	50	25
40	50	32
40	50	40
40	50	45
40	50	50
40	50	60
45	51	28
45	51	36
45	51	45
45	51	56
45	55	30
45	55	35
45	55	40
45	55	45
45	55	50
45	55	55
45	55	60
45	56	28
45	56	36
45	56	45
45	56	56
45	60	40
45	60	45
45	60	50
45	60	60
50	56	32
50	56	40
50	56	50
50	56	63
50	60	32
50	60	40
50	60	45
50	60	50
50	60	60
55	65	40
55	65	55
55	65	70
60	70	50
60	70	60
60	70	90
60	70	120
60	72	50
60	72	60
60	72	70
60	80	90
60	80	120
63	70	40
63	70	50
70	80	90
70	80	120
80	100	80
80	100	120
100	120	80
100	120	120

19001

CASQUILLOS DE BRONCE SINTERIZADO AUTOLUBRICADO



19001B...
Con valona

d	D	L	/	D1	e
3	6	4	/	9	1,5
3	6	5	/	9	1,5
3	6	6	/	9	1,5
3	6	10	/	9	1,5
4	8	4	/	12	2
4	8	5	/	12	2
4	8	8	/	12	2
4	8	10	/	12	2
4	8	12	/	12	2
6	10	6	/	14	2
6	10	10	/	14	2
6	10	15	/	14	2
6	10	26	/	14	2
8	12	8	/	16	2
8	12	10	/	16	2
8	12	12	/	16	2
8	12	15	/	16	2
8	12	16	/	16	2
9	14	6	/	19	2,5
9	14	10	/	19	2,5
9	14	14	/	19	2,5
10	13	10	/	16	1,5
10	13	16	/	16	1,5
10	13	20	/	16	1,5
10	14	10	/	18	2
10	14	15	/	18	2
10	14	20	/	18	2
10	15	10	/	20	3
10	15	15	/	20	3
10	15	16	/	20	3
10	15	20	/	20	3
10	16	8	/	22	3
10	16	10	/	22	3
10	16	16	/	22	3
12	15	12	/	18	1,5
12	15	16	/	18	1,5
12	15	20	/	18	1,5
12	17	10	/	22	3
12	17	12	/	22	3



19001C...
Estérico

d mm	D mm	L mm
4	10	8
5	12	9
6	14	11
7	16	12
8	18	13
9	20	14,5
10	22	16
12	23	16



19001D...
Estérico con cuello

d mm	C mm	D mm	L mm
4	10	6	10
5	12	8	11
6	14	9	13
7	16	10,5	14
8	18	12,5	16
9	20	14	17
10	22	15	18
12	23	17,5	18

d	D	L	/	D1	e
12	17	15	/	22	3
12	17	16	/	22	3
12	17	20	/	22	3
12	17	25	/	22	3
12	18	8	/	24	3
12	18	12	/	24	3
12	18	20	/	24	3
14	18	14	/	22	2
14	18	18	/	22	2
14	18	22	/	22	2
14	20	14	/	25	3
14	20	15	/	25	3
14	20	18	/	25	3
14	20	20	/	25	3
14	20	22	/	25	3
14	20	25	/	25	3
14	20	28	/	25	3
14	20	30	/	25	3
15	19	16	/	23	2
15	19	20	/	23	2
15	19	25	/	23	2
15	20	15	/	25	3
15	20	20	/	25	3
15	20	25	/	25	3
15	20	30	/	25	3
15	21	16	/	27	3
15	21	20	/	27	3
15	21	25	/	27	3
15	21	32	/	27	3
16	20	16	/	24	2
16	20	20	/	24	2
16	20	25	/	24	2
16	22	15	/	28	3
16	22	16	/	28	3
16	22	20	/	28	3
16	22	25	/	28	3
16	22	30	/	28	3
16	22	32	/	28	3
18	22	18	/	26	2
18	22	22	/	26	2
18	22	28	/	26	2
18	24	18	/	30	3
18	24	22	/	30	3
18	24	28	/	30	3
18	25	20	/	32	4
18	25	25	/	32	4
18	25	30	/	32	4
18	25	35	/	32	4
20	24	10	/	28	2
20	24	16	/	28	2
20	24	20	/	28	2
20	24	25	/	28	2
20	26	15	/	32	3
20	26	16	/	32	3

d	D	L	/	D1	e
20	26	20	/	32	3
20	26	25	/	32	3
20	26	30	/	32	3
20	26	32	/	32	3
20	28	20	/	35	4
20	28	25	/	35	4
20	28	30	/	35	4
20	28	35	/	35	4
22	27	18	/	32	2,5
22	27	22	/	32	2,5
22	27	28	/	32	2,5
22	28	15	/	33	4
22	28	20	/	33	4
22	28	25	/	33	4
22	28	30	/	33	4
22	28	35	/	33	4
22	28	40	/	33	4
22	29	18	/	36	3,5
22	29	22	/	36	3,5
22	29	28	/	36	3,5
22	29	36	/	36	3,5
25	30	20	/	35	2,5
25	30	25	/	35	2,5
25	30	32	/	35	2,5
25	32	20	/	40	4
25	32	25	/	40	4
25	32	30	/	40	4
25	32	32	/	40	4
25	32	35	/	40	4
25	32	40	/	40	4
25	35	16	/	45	5
25	35	25	/	45	5
25	35	30	/	45	5
28	33	22	/	44	4
28	33	28	/	44	4
28	33	36	/	44	4
28	36	22	/	44	4
28	36	25	/	44	4
28	36	28	/	44	4
28	36	30	/	44	4
28	36	35	/	44	4
28	36	36	/	44	4
28	36	40	/	44	4
30	38	20	/	46	4
30	38	25	/	46	4
30	38	30	/	46	4

d	D	L	/	D1	e
30	40	25	/	48	4
30	40	30	/	48	4
30	40	35	/	48	4
30	40	40	/	48	4
32	38	20	/	44	3
32	38	25	/	44	3
32	38	32	/	44	3
32	40	20	/	48	4
32	40	25	/	48	4
32	40	30	/	48	4
32	40	32	/	48	4
32	40	35	/	48	4
32	40	40	/	48	4
35	45	20	/	55	5
35	45	25	/	55	5
35	45	30	/	55	5
35	45	35	/	55	5
35	45	40	/	55	5
36	42	22	/	48	3
36	42	28	/	48	3
36	42	36	/	48	3
36	45	22	/	54	4,5
36	45	28	/	54	4,5
36	45	36	/	54	4,5
40	46	25	/	52	3
40	46	32	/	52	3
40	46	40	/	52	3
40	50	25	/	60	5
40	50	30	/	60	5
40	50	32	/	60	5
40	50	35	/	60	5
40	50	40	/	60	5
45	51	28	/	57	3
45	51	36	/	57	3
45	51	45	/	57	3
45	56	28	/	67	5,5
45	56	36	/	67	5,5
45	56	45	/	67	5,5
50	56	32	/	62	3
50	56	40	/	62	3
50	56	50	/	62	3
50	60	32	/	70	5
50	60	40	/	70	5
50	60	50	/	70	5
50	70	50	/	80	5
50	70	50	/	80	5

Barras para mecanizar



19001AA...
Macizas

D mm	L mm
10	30
15	25
20	50

D mm	L mm
25	25
25	50
32	40
32	80
42	50
42	100
45	90
52	60
52	120
62	120
70	120
80	120
105	120

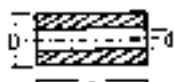

19001AB...
Huecas

d mm	D mm	L mm
38	66	65
38	66	120
45	105	120
53	85	65
53	85	120
68	104	65
68	104	120
83	123	65
83	123	120
98	142	65
98	142	120

19002

CASQUILLOS Y DISCOS DE FRICCIÓN PERMAGLIDE®

CON DORSO DE ACERO, LIBRES DE MANTENIMIENTO

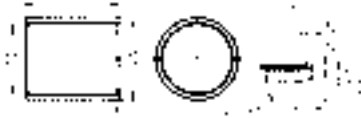

SERIE PAP...P10

Modelo	d1mm	d2mm	bmm
PAP 0203 P10	2	3,5	3
PAP 0205 P10	2	3,5	5
PAP 0303 P10	3	4,5	3
PAP 0304 P10	3	4,5	4
PAP 0305 P10	3	4,5	5
PAP 0306 P10	3	4,5	6
PAP 0403 P10	4	5,5	3
PAP 0404 P10	4	5,5	4
PAP 0406 P10	4	5,5	6
PAP 0410 P10	4	5,5	10
PAP 0505 P10	5	7	5
PAP 0508 P10	5	7	8
PAP 0510 P10	5	7	10
PAP 0606 P10	6	8	6
PAP 0608 P10	6	8	8
PAP 0610 P10	6	8	10
PAP 0710 P10	7	9	10
PAP 0808 P10	8	10	8
PAP 0810 P10	8	10	10
PAP 0812 P10	8	10	12
PAP 1008 P10	10	12	8
PAP 1010 P10	10	12	10
PAP 1012 P10	10	12	12
PAP 1015 P10	10	12	15
PAP 1020 P10	10	12	20
PAP 1208 P10	12	14	8
PAP 1210 P10	12	14	10
PAP 1214 P10	12	14	12
PAP 1215 P10	12	14	15
PAP 1220 P10	12	14	20
PAP 1225 P10	12	14	25
PAP 1310 P10	13	15	10
PAP 1410 P10	14	16	10
PAP 1412 P10	14	16	12
PAP 1415 P10	14	16	15
PAP 1420 P10	14	16	20
PAP 1425 P10	14	16	25
PAP 1510 P10	15	17	10
PAP 1512 P10	15	17	12
PAP 1515 P10	15	17	15
PAP 1520 P10	15	17	20
PAP 1525 P10	15	17	25
PAP 1610 P10	16	18	10
PAP 1612 P10	16	18	12
PAP 1615 P10	16	18	15
PAP 1620 P10	16	18	20
PAP 1625 P10	16	18	25
PAP 1810 P10	18	20	10
PAP 1815 P10	18	20	15
PAP 1820 P10	18	20	20

Modelo	d1mm	d2mm	bmm
PAP 1825 P10	18	20	25
PAP 2010 P10	20	23	10
PAP 2015 P10	20	23	15
PAP 2020 P10	20	23	20
PAP 2025 P10	20	23	25
PAP 2030 P10	20	23	30
PAP 2215 P10	22	25	15
PAP 2220 P10	22	25	20
PAP 2225 P10	22	25	25
PAP 2230 P10	22	25	30
PAP 2415 P10	24	27	15
PAP 2420 P10	24	27	20
PAP 2425 P10	24	27	25
PAP 2430 P10	24	27	30
PAP 2510 P10	25	28	10
PAP 2515 P10	25	28	15
PAP 2520 P10	25	28	20
PAP 2525 P10	25	28	25
PAP 2530 P10	25	28	30
PAP 2540 P10	25	28	40
PAP 2550 P10	25	28	50
PAP 2820 P10	28	32	20
PAP 2830 P10	28	32	30
PAP 3015 P10	30	34	15
PAP 3020 P10	30	34	20
PAP 3025 P10	30	34	25
PAP 3030 P10	30	34	30
PAP 3040 P10	30	34	40
PAP 3230 P10	32	36	30
PAP 3240 P10	32	36	40
PAP 3520 P10	35	39	20
PAP 3530 P10	35	39	30
PAP 3540 P10	35	39	40
PAP 3550 P10	35	39	50
PAP 4020 P10	40	44	20
PAP 4030 P10	40	44	30
PAP 4040 P10	40	44	40
PAP 4050 P10	40	44	50
PAP 4530 P10	45	50	30
PAP 4540 P10	45	50	40
PAP 4550 P10	45	50	50
PAP 5020 P10	50	55	20
PAP 5030 P10	50	55	30
PAP 5040 P10	50	55	40
PAP 5060 P10	50	55	60

**CONSULTAR MEDIDAS
MAYORES**

19002

CASQUILLOS Y DISCOS DE FRICCIÓN PERMAGLIDE®

CON DORSO DE ACERO, LIBRES DE MANTENIMIENTO

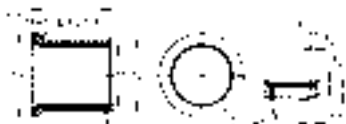

SERIE PAF...P10

Modelo	d1mm	d2mm	bmm
PAF 06040 P10	6	8	4
PAF 06070 P10	6	8	7
PAF 06080 P10	6	8	8
PAF 08055 P10	8	10	5,5
PAF 08075 P10	8	10	7,5
PAF 08095 P10	8	10	9,5
PAF 10070 P10	10	12	7
PAF 10090 P10	10	12	9
PAF 10120 P10	10	12	12
PAF 10170 P10	10	12	17
PAF 12070 P10	12	14	7
PAF 12090 P10	12	14	9
PAF 12120 P10	12	14	12
PAF 12170 P10	12	14	17
PAF 14120 P10	14	16	12
PAF 14170 P10	14	16	17
PAF 15090 P10	15	17	9
PAF 15120 P10	15	17	12

Modelo	d1mm	d2mm	bmm
PAF 15170 P10	15	17	17
PAF 16120 P10	16	18	12
PAF 16170 P10	16	18	17
PAF 18120 P10	18	20	12
PAF 18170 P10	18	20	17
PAF 18220 P10	18	20	22
PAF 20115 P10	20	23	11,5
PAF 20165 P10	20	23	16,5
PAF 20215 P10	20	23	21,5
PAF 25115 P10	25	28	11,5
PAF 25165 P10	25	28	16,5
PAF 25215 P10	25	28	21,5
PAF 30160 P10	30	34	16
PAF 30260 P10	30	34	26
PAF 35160 P10	35	39	16
PAF 35260 P10	35	39	26
PAF 40260 P10	40	44	26



SERIE PAW...P10

Modelo	d1mm	d2mm	bmm
PAW 10 P10	10	20	1,5
PAW 12 P10	12	24	1,5
PAW 14 P10	14	26	1,5
PAW 16 P10	16	30	1,5
PAW 18 P10	18	32	1,5
PAW 20 P10	20	36	1,5
PAW 22 P10	22	38	1,5

Modelo	d1mm	d2mm	bmm
PAW 26 P10	26	44	1,5
PAW 28 P10	28	48	1,5
PAW 32 P10	32	54	1,5
PAW 38 P10	38	62	1,5
PAW 42 P10	42	66	1,5
PAW 48 P10	48	74	2
PAW 52 P10	52	78	2
PAW 62 P10	62	90	2

CON DORSO DE BRONCE, LIBRES DE MANTENIMIENTO

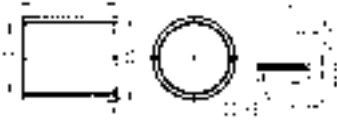

SERIE PAP...P11

Modelo	d1mm	d2mm	bmm
PAP 2525 P11	25	28	25
PAP 2530 P11	25	28	30
PAP 2830 P11	28	32	30
PAP 3020 P11	30	34	20
PAP 3030 P11	30	34	30
PAP 3040 P11	30	34	40
PAP 3520 P11	35	39	20
PAP 3530 P11	35	39	30
PAP 4050 P11	40	44	50
PAP 4550 P11	45	50	50
PAP 5030 P11	50	55	30
PAP 5040 P11	50	55	40
PAP 5060 P11	50	55	60
PAP 5540 P11	55	60	40

Modelo	d1mm	d2mm	bmm
PAP 6040 P11	60	65	40
PAP 6050 P11	60	65	50
PAP 6060 P11	60	65	60
PAP 6070 P11	60	65	70
PAP 7050 P11	70	75	50
PAP 7070 P11	70	75	70
PAP 8060 P11	80	85	60
PAP 80100 P11	80	85	100
PAP 9060 P11	90	95	60
PAP 90100 P11	90	95	100
PAP 9560 P11	95	100	60
PAP 10060 P11	100	105	60
PAP 10011 P11	100	105	115

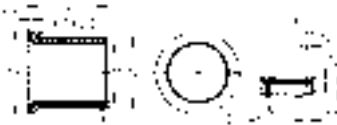

SERIE PAF...P11

Modelo	d4 mm	d5 mm	S3 mm
PAF 06080 P11	6	8	8
PAF 08055 P11	8	10	5,5
PAF 08095 P11	8	10	9,5
PAF 10070 P11	10	12	7
PAF 10120 P11	10	12	12
PAF 10170 P11	10	12	17
PAF 12070 P11	12	14	7
PAF 12090 P11	12	14	9
PAF 12120 P11	12	14	12
PAF 15120 P11	15	7	12

Modelo	d4 mm	d5 mm	S3 mm
PAF 15170 P11	15	17	17
PAF 16120 P11	16	18	12
PAF 18100 P11	18	20	10
PAF 18220 P11	18	20	22
PAF 20115 P11	20	23	11,5
PAF 20165 P11	20	23	16,5
PAF 25215 P11	25	28	21,5
PAF 30160 P11	30	34	16
PAF 30260 P11	30	34	26
PAF 35260 P11	35	39	26
PAF 40260 P11	40	44	26

19002

CASQUILLOS Y DISCOS DE FRICCIÓN PERMAGLIDE®

CON ALVEOLOS DE ENGRASE, DE ESCASO MANTENIMIENTO

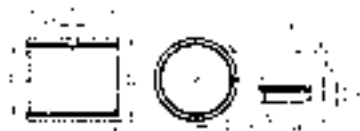

SERIE PAP...P20

Modelo	d1mm	d2mm	bmm
PAP 0808 P20	8	10	8
PAP 0810 P20	8	10	10
PAP 0812 P20	8	10	12
PAP 1008 P20	10	12	8
PAP 1010 P20	10	12	10
PAP 1015 P20	10	12	15
PAP 1210 P20	12	14	10
PAP 1212 P20	12	14	12
PAP 1215 P20	12	14	15
PAP 1220 P20	12	14	20
PAP 1420 P20	14	16	20
PAP 1510 P20	15	17	10
PAP 1515 P20	15	17	15
PAP 1525 P20	15	17	25
PAP 1612 P20	16	18	12
PAP 1615 P20	16	18	15
PAP 1620 P20	16	18	20
PAP 1815 P20	18	20	15
PAP 1820 P20	18	20	20
PAP 2015 P20	20	23	15
PAP 2020 P20	20	23	20
PAP 2025 P20	20	23	25
PAP 2030 P20	20	23	30
PAP 2220 P20	22	25	20
PAP 2515 P20	25	28	15
PAP 2520 P20	25	28	20
PAP 2525 P20	25	28	25
PAP 2530 P20	25	28	30
PAP 2830 P20	28	32	30
PAP 3020 P20	30	34	20
PAP 3025 P20	30	34	25

Modelo	d1mm	d2mm	bmm
PAP 3030 P20	30	34	30
PAP 3040 P20	30	34	40
PAP 3230 P20	32	36	30
PAP 3520 P20	35	39	20
PAP 3530 P20	35	39	30
PAP 3550 P20	35	39	50
PAP 4020 P20	40	44	20
PAP 4030 P20	40	44	30
PAP 4040 P20	40	44	40
PAP 4050 P20	40	44	50
PAP 4550 P20	45	50	50
PAP 5025 P20	50	55	25
PAP 5040 P20	50	55	40
PAP 5060 P20	50	55	60
PAP 5540 P20	55	60	40
PAP 6030 P20	60	65	30
PAP 6040 P20	60	65	40
PAP 6060 P20	60	65	60
PAP 7040 P20	70	75	40
PAP 7050 P20	70	75	50
PAP 7070 P20	70	75	70
PAP 7540 P20	75	80	40
PAP 7580 P20	75	80	80
PAP 8040 P20	80	85	40
PAP 8055 P20	80	85	55
PAP 8060 P20	80	85	60
PAP 8080 P20	80	85	80
PAP 9060 P20	90	95	60
PAP 10050 P20	100	105	50
PAP 10060 P20	100	105	60



SERIE PAW...P20

Modelo	d4 mm	d5 mm	S3 mm
PAW 12 P20	12	24	1,5
PAW 14 P20	14	26	1,5
PAW 18 P20	18	32	1,5
PAW 20 P20	20	36	1,5
PAW 22 P20	22	38	1,5
PAW 26 P20	26	44	1,5

Modelo	d4 mm	d5 mm	S3 mm
PAW 28 P20	28	48	1,5
PAW 32 P20	32	54	1,5
PAW 38 P20	38	62	1,5
PAW 42 P20	42	66	1,5
PAW 48 P20	48	74	2
PAW 52 P20	52	78	2

19003

JUNTAS UNIVERSALES

CON COJINETE DE AGUJAS

- S=Simple máx. α 45°
- D=Doble máx. α 90°
- DIN 808-7551
- Alta velocidad



Simple (S)

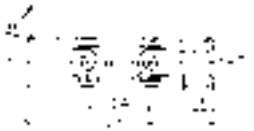

Doble (D)

Modelo S	Modelo D	dH7 mm	D mm	L1 mm	L2 mm	D1 mm	L3 mm	L4 mm	L5 mm	b mm	t mm	SH8 mm	WH8 mm
102V	-	8	16	52	15	-	-	-	-	2	9	-	-
103V	-	10	20	62	18	-	-	-	-	3	11,4	10	10
105V	105DV	14	25	74	20	25	104	30	20	5	16,3	14	14
106V	106DV	16	32	86	23	32	124	38	23	5	18,3	16	16
107V	-	18	37	72	17	-	-	-	-	6	20,8	17	18
108V	108DV	20	40	108	30	40	156	48	30	6	22,8	20	20
109V	-	22	47	95	22	-	-	-	-	6	24,8	22	22
110V	110DV	25	50	132	32	50	188	56	32	8	28,3	25	25
111V	111DV	30	63	166	38	63	238	80	38	8	33,3	30	30
112V	112DV	35	70	140	35	70	212	78	30	10	38,3	-	35
113V	113DV	40	80	180	50	80	290	120	48	12	43,3	-	35
114V	114DV	50	95	190	54	95	290	120	50	14	53,3	-	35

● Cardan extensible

Forma:

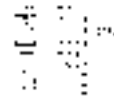
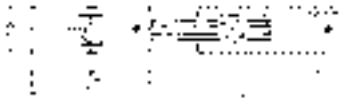

Modelo	dH7 mm	D mm	L1 mm	L2 mm	b x t mm	SH8 mm	SWH8 mm	E mm	F mm	Medidas normalizadas	
										L mín. mm	L máx. mm
124V	8	16	52	15	2 x 9	-	-	-	-	146 / 186	166 / 246
125V	10	20	62	18	3 x 11,4	10	10	11	14	156 / 196	176 / 256
127V	14	25	74	20	5 x 16,3	14	14	13	16	187 / 237	217 / 307
128V	16	32	85	23	5 x 18,3	16	16	16	20	212 / 282	242 / 372
129V	18	37	72	17	6 x 20,8	17	18	16	20	195 / 270	225 / 370
130V	20	40	108	30	6 x 22,8	20	20	18	22	259 / 329	289 / 429
131V	22	47	95	22	6 x 24,8	22	22	21	25	250 / 330	280 / 430
132V	25	50	132	32	6 x 28,3	25	25	23	28	306 / 386	356 / 486
133V	30	63	166	38	8 x 33,3	30	30	32	38	386 / 466	456 / 576
134V	35	70	140	35	10 x 38,3	-	-	32	38	- / -	- / -
135V	40	80	180	50	12 x 43,3	-	-	42	48	- / -	- / -
136V	45	95	190	54	14 x 53,3	-	-	42	48	- / -	- / -

- Ejecución normal
- Agujero redondo, con chavetero, hexágono o cuadrado
- Eje estriado en la ejecución normal es trefilado
- Bajo demanda, puede ser fresado, templado y rectificando
- Otras medidas de longitud bajo demanda

19003

JUNTAS UNIVERSALES

SIN COJINETES - DIN 808

● Esta junta universal "Alta precisión" ha sido posible, a una esmerada construcción y de tolerancias ajustadísimas ● Todas las partes de la articulación en contacto están templadas, rectificadas y lapeadas.



Simple (S)

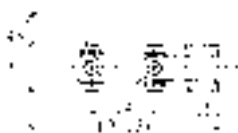

Doble (D)

Modelo S	Modelo D	dH7 mm	D mm	L1 mm	L1x mm	L2x mm	L2 mm	D1 mm	L3 mm	L3x mm	L4 mm	L5 mm	b mm	t mm	SH8 mm	SWH8 mm
101A	-	6	16	34	-	-	9	-	-	-	-	-	-	-	-	-
102A	-	8	16	40	-	-	11	-	-	-	-	-	2	9	-	-
103A	-	10	22	45	48	62	10	-	-	-	-	-	3	11,4	10	10
104A	104AD	12	25	50	56	-	11	22	74	86	29	15	4	13,8	12	12
105A	105AD	14	29	56	60	74	13	25	85	95	33	16	5	16,3	14	14
106A	106AD	16	32	65	68	86	15	29	100	104	35	19	5	18,3	16	16
107A	107AD	18	37	72	74	-	17	32	112	114	39	20	6	20,8	17	18
108A	108AD	20	40	82	108	-	19	40	127	128	46	20	6	22,8	20	20
109A	109AD	22	47	95	92	-	22	40	145	-	46	25	6	24,8	22	-
110A	110AD	25	50	108	105	132	27	50	163	-	59	25	8	28,3	25	25
111A	111AD	30	58	122	166	-	30	58	182	-	66	30	8	33,3	30	35
111/1A	111/1AD	32	63	130	-	-	30	63	198	-	66	30	10	35,3	30	35
112A	112AD	35	70	140	-	-	35	70	212	-	78	30	10	38,3	-	35
113A	113AD	40	80	160	-	-	42	80	245	-	95	38	12	43,3	-	35
114A	114AD	50	95	190	-	-	54	95	290	-	120	50	14	53,8	-	35

L1x, L2x, L3x: longitud bajo demanda.

● Cardan extensible

Forma:

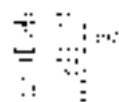
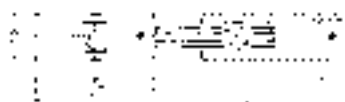

Modelo	dH7 mm	D mm	L1 mm	L2 mm	B mm	b x t mm	SH8 mm	SWH8 mm	E mm	F mm	Medidas normalizadas L mín. mm L máx. mm	
125A	10	22	45	10	40	3 x 11,4	10	10	11	14	130 / 170	150 / 230
126A	12	25	50	11	45	4 x 13,8	12	12	13	16	140 / 200	170 / 270
127A	14	29	56	13	48	5 x 16,3	14	14	13	16	160 / 210	190 / 280
128A	16	32	65	15	50	5 x 18,3	16	16	16	20	180 / 250	210 / 340
129A	18	37	72	17	51	6 x 20,8	17	18	16	20	195 / 270	225 / 370
130A	20	40	82	19	56	6 x 22,8	20	20	18	22	220 / 290	250 / 390
131A	22	47	95	22	60	6 x 24,8	22	22	21	25	250 / 330	280 / 430
132A	25	50	108	27	69	8 x 28,3	25	25	23	28	270 / 350	320 / 450
133A	30	58	122	30	70	8 x 33,3	30	35	26	32	320 / 400	390 / 510
134A	35	70	140	35	70	10 x 38,3	36	35	32	38	- / -	- / -
135A	40	80	160	42	70	12 x 43,3	41	35	42	48	- / -	- / -
136A	50	95	190	54	70	14 x 53,8	50	35	42	48	- / -	- / -

- Ejecución normal
- Agujero redondo, con chavetero, hexágono o cuadrado
- Eje estriado en la ejecución normal es trefilado
- Bajo demanda, puede ser fresado, templado y rectificado
- Otras medidas de longitud bajo demanda

SERIE AL



Simple (S)

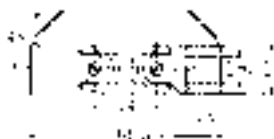

Doble (D)

Modelo S	Modelo D	d mm	D1 mm	D mm	L1 mm	L1x mm	L2x mm	L2 mm	L3 mm	L3x mm	L4 mm	L5 mm	S mm	SW mm	b x t mm
100AL	-	5	10	-	40	-	-	13	-	-	-	-	-	-	-
101AL	-	6	13	-	40	-	-	13	-	-	-	-	6	-	-
102AL	-	8	16	-	40	-	-	10	-	-	-	-	8	-	2 x 9
103AL	-	10	20	-	45	48	62	10	-	-	-	-	10	10	3 x 11,4
104AL	104DL	12	25	22	50	56	74	11	74	86	29	15	12	12	4 x 13,8
105AL	105DL	14	29	25	56	60	74	13	85	95	33	16	14	14	5 x 16,3
106AL	106DL	16	32	29	65	68	86	15	100	104	35	19	16	16	5 x 18,3
107AL	107DL	18	37	32	72	74	-	17	112	114	39	20	18	18	6 x 20,8
108AL	108DL	20	40	40	82	108	-	19	128	127	46	20	20	20	6 x 22,8
109AL	109DL	22	47	40	95	92	-	22	145	-	46	25	22	-	6 x 24,8
110AL	110DL	25	50	50	108	105	132	27	163	-	59	25	25	25	8 x 28,3
111AL	111DL	30	58	58	122	166	-	30	182	-	66	30	30	30	8 x 33,8

ACERO INOXIDABLE



Simple (S)



Doble (D)

Tipo	Junta simple 45°				Tipo	Junta doble 90°					Acoplam. Bajo demanda			
	dH7	D	L1	L2		DH7	D1	L3	L4	L5	S	SWH8	b x t	
100X	5	10	44	15	-	-	-	-	-	-	-	-	-	-
101X	6	13	50	18	-	-	-	-	-	-	6	-	-	-
102X	8	16	58	19	-	-	-	-	-	-	8	-	-	2 x 9
103X	10	20	64	19	-	-	-	-	-	-	10	10	-	3 x 11,4
104X	12	25	86	29	104DX	12	22	115	29	29	12	12	-	4 x 13,8
105X	14	29	90	30	105DX	14	25	123	33	30	14	14	-	5 x 16,3
106X	16	32	95	30	106DX	16	29	130	35	30	16	16	-	5 x 18,3
107X	18	37	108	35	107DX	18	32	147	39	35	18	18	-	6 x 20,8
108X	20	40	108	32	108DX	20	40	154	46	32	20	20	-	6 x 22,8
109X	22	47	127	38	109DX	22	40	173	46	38	22	-	-	6 x 24,8
110X	25	50	140	44	110DX	25	50	199	59	44	25	25	-	8 x 28,3
111X	30	58	178	58	111DX	30	58	244	66	58	30	30	-	8 x 33,8

19004

CUBIERTAS FLEXIBLES PROTECTORAS DE JUNTA UNIVERSAL



Tipo	Ø int. junta mm	Med. cubierta		
		A mm	B mm	C mm
103G	10	39	20,5	47
104G	12	47	24,5	52
105G	14	51	27,5	58
106G	16	56	30,5	67
107G	18	66	35,5	74
108G	20	75	40	84
109G	22	83	45	97
110G	25	93	50	110
111G	30	105	56	124

19 Rodamientos y cojinetes

Ejes estriados

19005

EJES ESTRIADOS

- DIN 5463



Modelo	∅ D -0,07 -0,27	∅ d -0,00 -0,07	Z	C +0,00 -0,08	Sección mm ²	Peso kg/m
SEE-14	14	11	6	3	121,9	0,95
SEE-16	16	13	6	3,5	164,1	1,28
SEE-20	20	16	6	4	243,4	1,91
SEE-22	22	18	6	5	312,4	2,45
SEE-25	25	21	6	5	399,8	3,14
SEE-28	28	23	6	6	505,2	3,96
SEE-32	32	26	6	6	638,6	5,00
SEE-38	38	32	8	6	947,8	7,43
SEE-48	48	42	8	8	1576,7	12,37

19006

CUBOS ESTRIADOS

- Cubo con brida de fijación



Modelo	Perfil	∅ D1 mm	∅ D2 mm	∅ D3 mm	L mm	B mm	Tal. Fijac. ∅M N° Tal.
SCBA-14	11 x 14	60	50	38	25	10	M6 3
SCBA-16	13 x 16	70	55	42	35	12	M6 4
SCBA-20	16 x 20	80	65	52	40	12	M6 4
	18 x 22						
SCBA-25	21 x 25	80	65	52	40	12	M6 4
	23 x 28						
SCBA-32	26 x 32	100	82	65	50	16	M8 4
	32 x 38						
	42 x 48						

19007

CASQUILLOS ESTRIADOS

- Casquillo estriado

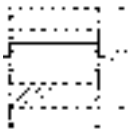

Modelo	∅ D mm	L mm
SCB-14	28	25
SCB-16	33	35
SCB-20	38	40
SCB-22	33	45
SCB-25	48	40
SCB-28	41	48
SCB-32	58	50
SCB-38	60	55
SCB-48	82	75

19008

ARTICULACION ANGULAR

- DIN 71802

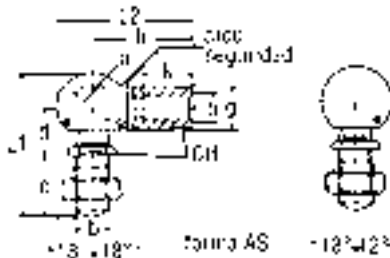

Modelo	a	b	c	d	g	h	L1	L2	k	CH
1900805	8	M5	10	9	8	22	25,2	28,5	10,2	-
1900806	10	M6	12,5	11	10	25	30,2	32,5	11,5	8
1900808	13	M8	16,5	13	13	30	38,2	39,5	14	11
1900810	16	M10	20	16	16	35	47,5	47	15,5	13
1900814	19	M14 x 1,5	28	21	22	45	62,5	60	21,5	-

19009 ROTULAS



- Requieren mantenimiento
- DIN 648 - serie de medidas E - ISO 6 124-1
- Superficies de fricción acero/acero

SERIE GE...DO



SERIE GE...DO-2RS

Con obturadores

Modelo	d mm	D mm	B mm	Cmm
GE 6 DO	6	14	6	4
GE 8 DO	8	16	8	5
GE 10 DO	10	19	9	6
GE 12 DO	12	22	10	7
GE 15 DO	15	26	12	9
GE 16 DO	16	30	14	10
GE 17 DO	17	30	14	10
GE 20 DO	20	35	16	12
GE 25 DO	25	42	20	16
GE 30 DO	30	47	22	18
GE 35 DO	35	55	25	20
GE 40 DO	40	62	28	22
GE 45 DO	45	68	32	25
GE 50 DO	50	75	35	28
GE 60 DO	60	90	44	36
GE 70 DO	70	105	49	40
GE 80 DO	80	120	55	45
GE 90 DO	90	130	60	50
GE 100 DO	100	150	70	55
GE 110 DO	110	160	70	55
GE 120 DO	120	180	85	70
GE 140 DO	140	210	90	70
GE 160 DO	160	230	105	80
GE 180 DO	180	260	105	80
GE 200 DO	200	290	130	100

Modelo	d mm	D mm	B mm	Cmm
GE 15 DO-2RS	15	26	12	9
GE 17 DO-2RS	17	30	14	10
GE 20 DO-2RS	20	35	16	12
GE 25 DO-2RS	25	42	20	16
GE 30 DO-2RS	30	47	22	18
GE 35 DO-2RS	35	55	25	20
GE 40 DO-2RS	40	62	28	22
GE 45 DO-2RS	45	68	32	25
GE 50 DO-2RS	50	75	35	28
GE 60 DO-2RS	60	90	44	36
GE 70 DO-2RS	70	105	49	40
GE 80 DO-2RS	80	120	55	45
GE 90 DO-2RS	90	130	60	50
GE 100 DO-2RS	100	150	70	55
GE 110 DO-2RS	110	160	70	55
GE 120 DO-2RS	120	180	85	70
GE 140 DO-2RS	140	210	90	70
GE 160 DO-2RS	160	230	105	80
GE 180 DO-2RS	180	260	105	80
GE 200 DO-2RS	200	290	130	100
GE 220 DO-2RS	220	320	135	100
GE 240 DO-2RS	240	340	140	100
GE 260 DO-2RS	260	370	150	110
GE 280 DO-2RS	280	400	155	120
GE 300 DO-2RS	300	430	165	120



- Requieren mantenimiento
- DIN 648 - serie de medidas EW - ISO 6 124-1
- Superficies de fricción acero/acero

SERIE GE...LO



SERIE GE...HO-2RS

Con obturadores

Modelo	d mm	D mm	B mm	Cmm
GE 12 LO	12	22	12	7
GE 16 LO	16	28	16	9
GE 20 LO	20	35	20	12
GE 25 LO	25	42	25	16
GE 32 LO	32	52	32	18
GE 40 LO	40	62	40	22
GE 50 LO	50	75	50	28
GE 63 LO	63	95	63	36
GE 70 LO	70	105	70	40
GE 80 LO	80	120	80	45
GE 90 LO	90	130	90	50
GE 100 LO	100	150	100	55
GE 110 LO	110	160	110	55
GE 125 LO	125	180	125	70

Modelo	d mm	D mm	B mm	Cmm
GE 20 HO-2RS	20	35	24	12
GE 25 HO-2RS	25	42	29	16
GE 30 HO-2RS	30	47	30	18
GE 35 HO-2RS	35	55	35	20
GE 40 HO-2RS	40	62	38	22
GE 45 HO-2RS	45	68	40	25
GE 50 HO-2RS	50	75	43	28
GE 60 HO-2RS	60	90	54	36
GE 70 HO-2RS	70	105	65	40
GE 80 HO-2RS	80	120	74	45

19009 ROTULAS



- Requieren mantenimiento
- DIN 648 - serie de medidas G - ISO 6 124-1
- Superficies de fricción acero/acero

SERIE GE...FO-2RS

Con obturadores

Modelo	d mm	D mm	B mm	Cmm
GE 20 FO-2RS	20	42	25	16
GE 25 FO-2RS	25	47	28	18
GE 30 FO-2RS	30	55	32	20
GE 35 FO-2RS	35	62	35	22
GE 40 FO-2RS	40	68	40	25
GE 45 FO-2RS	45	75	43	28
GE 50 FO-2RS	50	90	56	36
GE 60 FO-2RS	60	105	63	40
GE 70 FO-2RS	70	120	70	45
GE 80 FO-2RS	80	130	75	50
GE 90 FO-2RS	90	150	85	55
GE 100 FO-2RS	100	160	85	55
GE 110 FO-2RS	110	180	100	70



- Requieren mantenimiento
- Superficies de fricción acero/acero

SERIE GE...AX

Modelo	d mm	D mm	B mm	Cmm
GE 10 AX	10	30	9,5	6
GE 12 AX	12	35	13	9
GE 15 AX	15	42	15	11
GE 17 AX	17	47	16	11,5
GE 20 AX	20	55	20	13
GE 25 AX	25	62	22,5	17
GE 30 AX	30	75	26	19,5
GE 35 AX	35	90	28	20
GE 40 AX	40	105	32	22
GE 45 AX	45	120	36,5	25

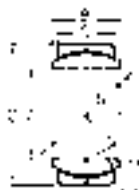

- Libre de mantenimiento
- DIN 648 - serie de medidas E - ISO 6 124-1
- Superficies de fricción cromo duro/ compuesto de PTFE

SERIE GE...UK

Modelo	d mm	D mm	B mm	Cmm
GE 6 UK	6	14	6	4
GE 8 UK	8	16	8	5
GE 10 UK	10	19	9	6
GE 12 UK	12	22	10	7
GE 15 UK	15	26	12	9
GE 17 UK	17	30	14	10
GE 20 UK	20	35	16	12
GE 25 UK	25	42	20	16
GE 30 UK	30	47	22	18

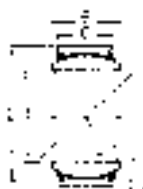

SERIE GE...UK-2RS

Con obturadores

Modelo	d mm	D mm	B mm	Cmm
GE 17 UK-2RS	17	30	14	10
GE 20 UK-2RS	20	35	16	12
GE 25 UK-2RS	25	42	20	16
GE 30 UK-2RS	30	47	22	18
GE 35 UK-2RS	35	55	25	20
GE 40 UK-2RS	40	62	28	22
GE 45 UK-2RS	45	68	32	25
GE 50 UK-2RS	50	75	35	28
GE 60 UK-2RS	60	90	44	36
GE 70 UK-2RS	70	105	49	40
GE 80 UK-2RS	80	120	55	45
GE 90 UK-2RS	90	130	60	50
GE 100 UK-2RS	100	150	70	55
GE 110 UK-2RS	110	160	70	55
GE 120 UK-2RS	120	180	85	70
GE 140 UK-2RS	140	210	90	70
GE 160 UK-2RS	160	230	105	80
GE 180 UK-2RS	180	260	105	80
GE 200 UK-2RS	200	290	130	100
GE 220 UK-2RS	220	320	135	100
GE 240 UK-2RS	240	340	140	100
GE 260 UK-2RS	260	370	150	110
GE 280 UK-2RS	280	400	155	120
GE 300 UK-2RS	300	430	165	120

- Libre de mantenimiento
- DIN 648 - serie de medidas G - ISO 6 124-1
- Superficies de fricción cromo duro/ compuesto de PTFE



SERIE GE...FW

Superficies de fricción
cromo duro/tejido de PTFE

Modelo	d mm	D mm	B mm	Cmm
GE 10 FW	10	22	12	7
GE 12 FW	12	26	15	9
GE 15 FW	15	30	16	10
GE 17 FW	17	35	20	12
GE 20 FW	20	42	25	16
GE 25 FW	25	47	28	18



SERIE GE...FW-2RS

Con obturadores

Modelo	d mm	D mm	B mm	Cmm
GE 30 FW-2RS	30	55	32	20
GE 35 FW-2RS	35	62	35	22
GE 40 FW-2RS	40	68	40	25
GE 45 FW-2RS	45	75	43	28
GE 50 FW-2RS	50	90	56	36
GE 60 FW-2RS	60	105	63	40
GE 70 FW-2RS	70	120	70	45
GE 80 FW-2RS	80	130	75	50
GE 90 FW-2RS	90	150	85	55



- Libre de mantenimiento
- Superficies de fricción cromo duro/compuesto de PTFE

SERIE GE...AW

Modelo	d mm	D mm	B mm	Cmm
GE 17 AW	17	47	16	11,5
GE 20 AW	20	55	20	13
GE 25 AW	25	62	22,5	17
GE 30 AW	30	75	26	19,5
GE 35 AW	35	90	28	20
GE 40 AW	40	105	32	22
GE 45 AW	45	120	36,5	25
GE 50 AW	50	130	42,5	32
GE 60 AW	60	150	45	33
GE 70 AW	70	160	50	36
GE 80 AW	80	180	50	36
GE 100 AW	100	210	59	42
GE 120 AW	120	230	64	45

19010

CABEZAS DE ROTULA

CON MANTENIMIENTO

- DIN 648 - serie de medidas E - ISO 6 126
- Superficies de fricción acero/acero

SERIE GIR...DO

SERIE GIR...DO-2RS

Con obturadores

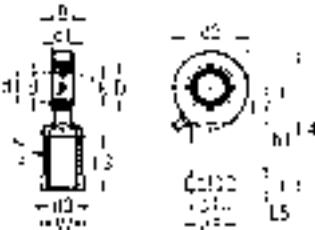

Modelo	d mm	B mm	d2 mm	d3 mm	l2 mm	h mm
GIR 6 DO	6	6	21	M 6	30	40,5
GIR 8 DO	8	8	24	M 8	36	57,5
GIR 10 DO	10	9	29	M 10	43	67
GIR 12 DO	12	10	34	M 12	50	81
GIR 15 DO	15	12	40	M 14	61	90
GIR 17 DO	17	14	46	M 16	67	103,5
GIR 20 DO	20	16	53	M 20 x 1,5	77	126
GIR 25 DO	25	20	64	M 24 x 2	94	146,5
GIR 30 DO	30	22	73	M 30 x 2	110	166
GIR 35 DO-2RS	35	25	82	M 36 x 3	125	188
GIR 40 DO-2RS	40	30	92	M 39 x 3	143	196
GIR 45 DO-2RS	45	32	102	M 42 x 3	145	216
GIR 50 DO-2RS	50	35	112	M 45 x 3	160	242,5
GIR 60 DO-2RS	60	44	135	M 52 x 3	175	280
GIR 70 DO-2RS	70	49	160	M 56 x 4	200	320
GIR 80 DO-2RS	80	55	180	M 64 x 4	230	

Suministrable con rosca izquierda
sustituir GIR...DO por GIL...DO

19010

CABEZAS DE ROTULA

CON MANTENIMIENTO



- DIN 648 - serie de medidas E - ISO 6 126
- Superficies de fricción acero/acero

SERIE GAR...DO

SERIE GAR...DO-2RS

Con obturadores

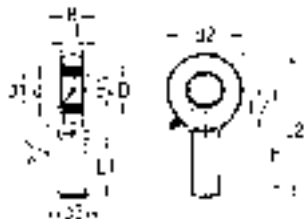

Modelo	d mm	B mm	d2 mm	d3 mm	l2 mm	h mm
GAR 6 DO	6	6	21	M 6	46,5	46,5
GAR 8 DO	8	8	24	M 8	54	54
GAR 10 DO	10	9	29	M 10	62,5	62,5
GAR 12 DO	12	10	34	M 12	71	71
GAR 15 DO	15	12	40	M 14	83	83
GAR 17 DO	17	14	46	M 16	92	92
GAR 20 DO	20	16	53	M 20 x 1,5	104,5	104,5
GAR 25 DO	25	20	64	M 24 x 2	126	126
GAR 30 DO	30	22	73	M 30 x 2	146,5	146,5
GAR 35 DO-2RS	35	25	82	M 36 x 3	181	181
GAR 40 DO-2RS	40	30	92	M 39 x 3	196	196
GAR 45 DO-2RS	45	32	102	M 42 x 3	214	214
GAR 50 DO-2RS	50	35	112	M 45 x 3	241	241
GAR 60 DO-2RS	60	44	135	M 52 x 3	277,5	277,5
GAR 70 DO-2RS	70	49	160	M 56 x 4	315	315
GAR 80 DO-2RS	80	55	180	M 64 x 4	360	360

**Suministrable con rosca izquierda
sustituir GAR...DO por GAL...DO**

- DIN 648 - serie de medidas K - ISO 6 126
- Superficies de fricción acero/bronce

SERIE GIKFR...PB



Modelo	d mm	B mm	d2 mm	d3 mm	h1 mm	L4 mm
GIKFR 5 PB	5	8	18	M 5	27	36
GIKFR 6 PB	6	9	20	M 6	30	40
GIKFR 8 PB	8	12	24	M 8	36	48
GIKFR 10 PB	10	14	28	M 10	43	57
GIKFR 12 PB	12	16	32	M 12	50	66
GIKFR 14 PB	14	19	36	M 14	57	75
GIKFR 16 PB	16	21	42	M 16	64	85
GIKFR 18 PB	18	23	46	M 18 x 1,5	71	94
GIKFR 20 PB	20	25	50	M 20 x 1,5	77	102
GIKFR 22 PB	22	28	54	M 22 x 1,5	84	111
GIKFR 25 PB	25	31	60	M 24 x 2	94	124
GIKFR 30 PB	30	37	70	M 30 x 2	110	145

- DIN 648 - serie de medidas K - ISO 6 126
- Superficies de fricción acero/bronce

SERIE GAKFR...PB

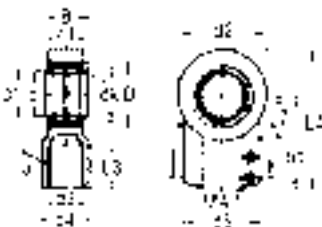

Modelo	d mm	B mm	d2 mm	d3 mm	L2 mm
GAKFR 5 PB	5	8	18	M 5	42
GAKFR 6 PB	6	9	20	M 6	46
GAKFR 8 PB	8	12	24	M 8	54
GAKFR 10 PB	10	14	28	M 10	62
GAKFR 12 PB	12	16	32	M 12	70
GAKFR 14 PB	14	19	36	M 14	78
GAKFR 16 PB	16	21	42	M 16	87
GAKFR 18 PB	18	23	46	M 18 x 1,5	95
GAKFR 20 PB	20	25	50	M 20 x 1,5	103
GAKFR 22 PB	22	28	54	M 22 x 1,5	111
GAKFR 25 PB	25	31	60	M 24 x 2	124
GAKFR 30 PB	30	37	70	M 30 x 2	145

LIBRES DE MANTENIMIENTO

- DIN 648 - serie de medidas E - ISO 6 126
- Superficies de fricción cromo duro/PTFE

SERIE GIR...UK

Material deslizante compuesto de PTFE

SERIE GIR...UK-2RS

Material deslizante tejido de PTFE
Con obturadores



Modelo	d mm	B mm	d2 mm	d3 mm	h1 mm	L4 mm
GIR 6 UK	6	6	21	M 6	30	40,5
GIR 8 UK	8	8	24	M 8	36	48
GIR 10 UK	10	9	29	M 10	43	57,5
GIR 12 UK	12	10	34	M 12	50	67
GIR 15 UK	15	12	40	M 14	61	81
GIR 17 UK	17	14	46	M 16	67	90
GIR 20 UK	20	16	53	M 20 x 1,5	77	103,5
GIR 25 UK	25	20	64	M 24 x 2	94	123
GIR 30 UK	30	22	73	M 30 x 2	110	146,5
GIR 35 UK-2RS	35	25	82	M 36 x 3	125	166
GIR 40 UK-2RS	40	30	92	M 39 x 3	142	188
GIR 45 UK-2RS	45	32	102	M 42 x 3	145	196
GIR 50 UK-2RS	50	35	112	M 45 x 3	160	216
GIR 60 UK-2RS	60	44	135	M 52 x 3	175	242,5
GIR 70 UK-2RS	70	49	160	M 56 x 4	200	280
GIR 80 UK-2RS	80	55	180	M 64 x 4	230	320

Suministrable con rosca izquierda
sustituir GIR...UK por GIL...UK

- DIN 648 - serie de medidas E - ISO 6 126
- Superficies de fricción cromo duro/PTFE

SERIE GAR...UK

Material deslizante compuesto de PTFE

SERIE GAR...UK-2RS

Material deslizante tejido de PTFE
Con obturadores

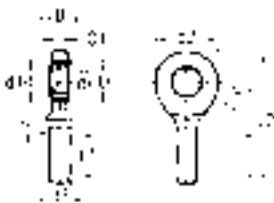

Modelo	d mm	B mm	d2 mm	d3 mm	h1 mm	L4 mm
GIR 6 UK	6	6	21	M 6	46,5	36
GIR 8 UK	8	8	24	M 8	54	42
GIR 10 UK	10	9	29	M 10	62,5	48
GIR 12 UK	12	10	34	M 12	71	54
GIR 15 UK	15	12	40	M 14	83	63
GIR 17 UK	17	14	46	M 16	92	69
GIR 20 UK	20	16	53	M 20 x 1,5	104,5	78
GIR 25 UK	25	20	64	M 24 x 2	126	94
GIR 30 UK	30	22	73	M 30 x 2	146,5	110
GIR 35 UK-2RS	35	25	82	M 36 x 3	181	140
GIR 40 UK-2RS	40	30	92	M 39 x 3	196	150
GIR 45 UK-2RS	45	32	102	M 42 x 3	214	163
GIR 50 UK-2RS	50	35	112	M 45 x 3	241	185
GIR 60 UK-2RS	60	44	135	M 52 x 3	277,5	210
GIR 70 UK-2RS	70	49	160	M 56 x 4	315	235
GIR 80 UK-2RS	80	55	180	M 64 x 4	360	270

Suministrable con rosca izquierda
sustituir GAR...UK por GAL...UK

- DIN 648 - serie de medidas K - ISO 6 126
- Superficies de fricción acero/lámina de PTFE

SERIE GIRFR...PW



Modelo	d mm	B mm	d2 mm	d3 mm	h1 mm	L4 mm
GIKFR 5 PW	5	8	18	M 5	27	36
GIKFR 6 PW	6	9	20	M 6	30	40
GIKFR 8 PW	8	12	24	M 8	36	48
GIKFR 10 PW	10	14	28	M 10	43	57
GIKFR 12 PW	12	16	32	M 12	50	66
GIKFR 14 PW	14	19	36	M 14	57	75
GIKFR 16 PW	16	21	42	M 16	64	85
GIKFR 18 PW	18	23	46	M 18 x 1,5	71	94
GIKFR 20 PW	20	25	50	M 20 x 1,5	77	102
GIKFR 22 PW	22	28	54	M 22 x 1,5	84	111
GIKFR 25 PW	25	31	60	M 24 x 2	94	124
GIKFR 30 PW	30	37	70	M 30 x 2	110	145

19010

CABEZAS DE ROTULA



LIBRES DE MANTENIMIENTO

SERIE GIPFR...PW



- DIN 648 - serie de medidas K - ISO 6 126
- Superficies de fricción acero/lámina de PTFE

Modelo	d mm	B mm	d2 mm	d3 mm	h1 mm	L4 mm
GIPFR 5 PW	5	8	18	M 5	27	36
GIPFR 10 PW	10	14	28	M 10	43	57
GIPFR 12 PW	12	16	32	M 12	50	66
GIPFR 16 PW	16	21	42	M 16	64	85
GIPFR 30 PW	30	37	70	M 30 x 2	110	145

- DIN 648 - serie de medidas K - ISO 6 126
- Superficies de fricción acero/lámina de PTFE

SERIE GAKFR...PW



Modelo	d mm	B mm	d2 mm	d3 mm	h1 mm	L4 mm
GAKFR 5 PW	5	8	18	M 5	33	42
GAKFR 6 PW	6	9	20	M 6	36	46
GAKFR 8 PW	8	12	24	M 8	42	54
GAKFR 10 PW	10	14	28	M 10	48	62
GAKFR 12 PW	12	16	32	M 12	54	70
GAKFR 14 PW	14	19	36	M 14	60	78
GAKFR 16 PW	16	21	42	M 16	66	87
GAKFR 18 PW	18	23	46	M 18 x 1,5	72	95
GAKFR 20 PW	20	25	50	M 20 x 1,5	78	103
GAKFR 22 PW	22	28	54	M 22 x 1,5	84	111
GAKFR 25 PW	25	31	60	M 24 x 2	94	124
GAKFR 30 PW	30	37	70	M 30 x 2	110	145

HIDRAULICAS

- Requieren mantenimiento
- DIN 24 338, ISO 6 982
- Superficies de fricción acero/acero

SERIE GIHN-K...LO

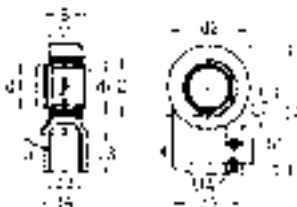

Modelo	d mm	B mm	d2 mm	d3 mm	h1 mm	L4 mm
GIHN-K 12 LO	12	12	32	M 12 x 1,25	38	54
GIHN-K 16 LO	16	16	40	M 14 x 1,5	44	64
GIHN-K 20 LO	20	20	47	M 16 x 1,5	52	75,2
GIHN-K 25 LO	25	25	58	M 20 x 1,5	65	94
GIHN-K 32 LO	32	32	70	M 27 x 2	80	115
GIHN-K 40 LO	40	40	89	M 33 x 2	97	141,5
GIHN-K 50 LO	50	50	108	M 42 x 2	120	174
GIHN-K 63 LO	63	63	132	M 48 x 2	140	211
GIHN-K 80 LO	80	80	168	M 64 x 3	180	270
GIHN-K 100 LO	100	100	210	M 80 x 3	210	322
GIHN-K 110 LO	110	110	235	M 90 x 3	235	364
GIHN-K 125 LO	125	125	262	M 100 x 3	260	405



- Requieren mantenimiento
- Superficies de fricción acero/acero

SERIE GIHR-K...DO

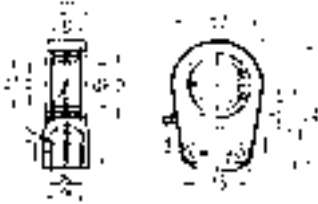

Modelo	d mm	B mm	d2 mm	d3 mm	h1 mm	L4 mm
GIHR-K 20 DO	20	16	56	M 16 x 1,5	50	78
GIHR-K 25 DO	25	20	56	M 16 x 1,5	50	78
GIHR-K 30 DO	30	22	64	M 22 x 1,5	60	92
GIHR-K 35 DO	35	25	78	M 28 x 1,5	70	109
GIHR-K 40 DO	40	28	94	M 35 x 1,5	85	132
GIHR-K 50 DO	50	35	116	M 45 x 1,5	105	163
GIHR-K 60 DO	60	44	130	M 58 x 1,5	130	200
GIHR-K 70 DO	70	49	154	M 65 x 1,5	150	232
GIHR-K 80 DO	80	55	176	M 80 x 2	170	265
GIHR-K 90 DO	90	60	206	M 100 x 2	210	323
GIHR-K 100 DO	100	70	230	M 110 x 2	235	360
GIHR-K 110 DO	110	70	265	M 120 x 3	265	407,5
GIHR-K 120 DO	120	85	340	M 130 x 3	310	490

- Requieren mantenimiento
- DIN 648 - Serie de medidas E
- Superficies de fricción acero/acero

SERIE GK...DO



Modelo	d mm	B mm	d2 mm	h2 mm	L6 mm
GK 17 DO	17	14	46	35	58
GK 20 DO	20	16	53	38	64,5
GK 25 DO	25	20	64	45	77
GK 30 DO	30	22	73	51	87,5
GK 35 DO	35	25	82	61	102
GK 40 DO	40	28	92	69	115
GK 45 DO	45	32	102	77	128
GK 50 DO	50	35	112	88	144
GK 60 DO	60	44	135	100	167,5
GK 70 DO	70	49	160	115	195
GK 80 DO	80	55	180	141	231

- Requieren mantenimiento
- Superficies de fricción acero/acero

SERIE GF...DO



Modelo	d mm	B mm	d2 mm	h2 mm	L6 mm
GF 20 DO	20	16	53	38	63
GF 25 DO	25	20	64	45	72,5
GF 30 DO	30	22	73	51	83,5
GF 35 DO	35	25	82	61	102,5
GF 40 DO	40	28	92	69	119
GF 45 DO	45	32	102	77	132
GF 50 DO	50	35	112	88	149,5
GF 60 DO	60	44	135	100	170
GF 70 DO	70	49	160	115	197
GF 80 DO	80	55	180	141	231

Rodamientos

OBTURACIONES

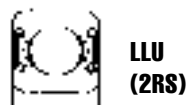
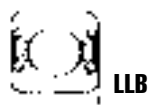
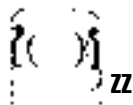

Ejecución	Características
ZZ	La tapa en chapa de acero, gracias al paso estrecho que forma con el anillo interior y con la ranura en -V-, logra una eficaz protección ● Esta tapa al no tener contacto con el anillo interior, el momento de rozamiento es igual al de los rodamientos sin obturación.
LLB Obturación Color negro	Esta tapa de obturación de caucho sintético (Buna N) reforzada con chapa de acero, es resistente al aceite y a la temperatura ● La forma de -V- tanto de la ranura como de la tapa, consigue una eficaz obturación debido al efecto de paso laberíntico ● Al igual que el las tapas ZZ, al no tener contacto esta tapa con el anillo interior, el momento de rozamiento es igual al de los rodamientos sin obturación.
LLU Obturación Color rojo	Esta tapa de obturación de caucho sintético (Buna N) reforzada con chapa de acero, es resistente al aceite y a la temperatura ● La forma de -V- tanto de la ranura como de la tapa como de los dos labios de la tapa, consigue además de una eficaz obturación una larga duración de funcionamiento ● El momento de rozamiento de esta obturación es algo mayor que en los rodamientos sin obturación.

IDENTIFICACION DE PREFIJOS Y SUFIJOS

Sufijos	Anillos
D	Agujero de engrase en el anillo exterior
D1	Ranura y agujeros de engrase en el anillo exterior
K	Agujero cónico: conicidad 1/12
K30	Agujero cónico: conicidad 1/30
N	Ranura circular en el anillo exterior, sin anillo elástico
NR	Ranura circular en el anillo exterior con su correspondiente anillo elástico

Sufijos	Para rodamientos apareados
DB	Rodamientos apareados, disposición en O
DF	Rodamientos apareados, disposición en X
DT	Rodamientos apareados, disposición en tándem
G	Rodamientos unitarios, apareado universal

Sufijos	Juegos internos
C1	Juego radial inferior a C2
C2	Juego radial inferior al normal
Sin signo	Juego radial normal
C3	Juego radial superior al normal
C4	Juego radial superior a C3
C5	Juego radial superior a C4
CS00	Juego radial especial, indicado en μm .
CM	Juego radial especial para rodamientos de motores eléctricos
ZS	Rodamientos de rodillos cilíndricos, tolerancia de juego reducido

Sufijos	Precisión
P4	Clase ISO 4
P5	Clase ISO 5
P6	Clase ISO 6

Sufijos	Lubricación
/2A	Grasa Shell Alvania 2
/5C	Grasa Caltex RPM SRI-2
/3E	Grasa Esso Beacon 325
/5K	Grasa Multemp SRL

19011

RODAMIENTOS RADIALES RIGIDOS



1 hilera de bolas

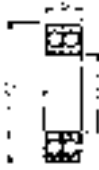

2 hileras de bolas

Modelo	d	D	B
681	1	3	1
MR31	1	3	1,5
691	1	4	1,6
MR41X	1,2	4	1,8
681X	1,5	4	1,2
691X	1,5	5	2
601X	1,5	6	2,5
682	2	5	1,5
MR52	2	5	2
692	2	6	2,3
MR62	2	6	2,5
MR72	2	7	2,5
602	2	7	2,8
682X	2,5	6	1,5
692X	2,5	7	2,5
MR82X	2,5	8	2,5
602X	2,5	8	2,8
MR63	3	6	2
683	3	7	2
MR83	3	8	2,5
693	3	8	3
MR93	3	9	2,5
603	3	9	3
623	3	10	4
633	3	13	5
MR74	4	7	2
MR84	4	8	2
684	4	9	2,5
MR104	4	10	3
694	4	11	4
604	4	12	4
624	4	13	5
634	4	16	5
MR85	5	8	2
MR95	5	9	2,5
MR105	5	10	3
MR115	5	11	—
685	5	11	3
695	5	13	4
605	5	14	5
625	5	16	5
635	5	19	6
MR106	6	10	2,5
MR126	6	12	3
686	6	13	3,5
696	6	15	5
606	6	17	6
626	6	19	6
636	6	22	7
MR117	7	11	2,5
MR137	7	13	3
687	7	14	3,5
697	7	17	5

Modelo	d	D	B
607	7	19	6
627	7	22	7
637	7	26	9
MR128	8	12	2,5
MR148	8	14	3,5
688	8	16	4
698	8	19	6
608	8	22	7
628	8	24	8
638	8	28	9
689	9	17	4
699	9	20	6
609	9	24	7
629	9	26	8
639	9	30	10
6700	10	15	3
61800	10	19	5
63800	10	19	7
6800W	10	19	4
61900	10	22	6
6900W	10	22	5
6000	10	26	8
630002RS	10	26	—
16100	10	28	8
6200	10	30	9
622002RS	10	30	—
4200	10	30	14
6300	10	35	11
623002RS	10	35	—
6701	12	18	4
61801	12	21	5
63801	12	21	7
6801W	12	21	4
61901	12	24	6
6901W	12	24	5
6001	12	28	8
630012RS	12	28	—
16101	12	30	8
6201	12	32	10
622012RS	12	32	—
4201	12	32	14
6301	12	37	12
623012RS	12	37	—
4301	12	37	17
6702	15	21	4
61802	15	24	5
63802	15	24	7
6802W	15	24	4
61902	15	28	7
6902W	15	28	5
16002	15	32	8
6002	15	32	9
630022RS	15	32	—

Modelo	d	D	B
6202	15	35	11
62202RS	15	35	—
4202	15	35	14
6302	15	42	13
623022RS	15	42	—
4302	15	42	17
6703	17	23	4
61803	17	26	5
63803	17	26	6
6803W	17	26	4
61903	17	30	7
6903W	17	30	5
16003	17	35	8
6003	17	35	10
630032RS	17	35	—
6203	17	40	12
622032RS	17	40	—
4203	17	40	16
6303	17	47	14
623032RS	17	47	—
4303	17	47	19
6403	17	62	17
6704	20	27	4
61804	20	32	7
63804	20	32	10
6804W	20	32	4
61904	20	37	9
6904W	20	37	7
16004	20	42	8
6004	20	42	12
630042RS	20	42	—
6204	20	47	14
622042RS	20	47	—
4204	20	47	18
6304	20	52	15
623042RS	20	52	—
4304	20	52	21
6404	20	72	19
60/22	22	44	12
62/22	22	50	14
63/22	22	56	16
61905	25	42	9
6905W	25	42	7
16005	25	47	8
6005	25	47	12
630052RS	25	47	—
6205	25	52	15
622052RS	25	52	—
4205	25	52	18
6305	25	62	17
6263052RS	25	62	—
4305	25	62	24
6405	25	80	21

Modelo	d	D	B
60/28	28	52	12
62/28	28	58	16
63/28	28	68	18
63806	30	42	10
6806W	30	42	4
61906	30	47	9
6906W	30	47	7
16006	30	55	9
6006	30	55	13
630062RS	30	55	—
6206	30	62	16
622062RS	30	62	—
4206	30	62	20
6306	30	72	19
623062RS	30	72	—
4306	30	72	27
6406	30	90	23
6707	35	44	5
61807	35	47	7
61907	35	55	10
16007	35	62	9
6007	35	62	14
630072RS	35	62	—
6207	35	72	17
622072RS	35	72	—
4207	35	72	23
6307	35	80	21
623072RS	35	80	—
4307	35	80	31
6407	35	100	25
6708	40	50	6
61808	40	52	7
61908	40	62	12
16008	40	68	9
6008	40	68	15
630082RS	40	68	—
6208	40	80	18
622082RS	40	80	—
4208	40	80	23
6308	40	90	23
623082RS	40	90	—
4308	40	90	33
6408	40	110	27
6709	45	55	6
61809	45	58	7
61909	45	68	12
16009	45	75	10
6009	45	75	16
630092RS	45	75	—
6209	45	85	19
622092RS	45	85	—
6309	45	100	25
623092RS	45	100	—

19 Rodamientos y cojinetes

Rodamientos radiales rígidos

19011

RODAMIENTOS RADIALES RIGIDOS

Modelo	d	D	B	Modelo	d	D	B	Modelo	d	D	B	Modelo	d	D	B
4309	45	100	36	601301	65	100	18	621701	85	150	28	61826	130	165	18
6409	45	120	29	630132RS	65	100	-	421702	85	150	36	61926	130	180	24
61810	50	65	7	621301	65	120	23	631701	85	180	41	16026	130	200	22
61910	50	72	12	622132RS	65	120	-	641701	85	210	52	6026	130	200	33
1601001	50	80	10	421302	65	120	31	61818	90	115	13	6226	130	230	40
601001	50	80	16	631301	65	140	33	61918	90	125	18	6326	130	280	58
630102RS	50	80	-	623132RS	65	140	-	1601801	90	140	16	61828	140	175	18
621001	50	90	20	431302	65	140	48	601801	90	140	24	61928	140	190	24
622102RS	50	90	-	641301	65	160	37	621801	90	160	30	16028	140	210	22
421002	50	90	23	61814	70	90	10	421802	90	160	40	6028	140	210	33
631001	50	110	27	61914	70	100	13	631801	90	190	43	6228	140	250	42
623102RS	50	110	-	1601401	70	110	11	641801	90	225	54	6328	140	300	62
431002	50	110	40	601401	70	110	18	61819	95	120	13	61830	150	190	20
641001	50	130	31	630142RS	70	110	-	61919	95	130	18	61930	150	210	28
61811	55	72	9	621401	70	125	23	1601901	95	145	16	16030	150	225	24
61911	55	80	13	622142RS	70	125	-	601901	95	145	24	6030	150	225	35
1601101	55	90	11	421402	70	125	31	621901	95	170	32	6230	150	270	45
601101	55	90	18	631401	70	150	33	631901	95	200	45	6330	150	320	65
630112RS	55	90	-	623142RS	70	150	-	61820	100	125	13	61832	160	200	20
621101	55	100	21	431402	70	150	48	61920	100	140	18	61932	160	220	28
622112RS	55	100	-	641401	70	180	37	1602001	100	150	16	16032	160	240	25
421102	55	100	25	61815	75	95	10	602001	100	150	24	6032	160	240	38
631101	55	120	29	61915	75	105	16	622001	100	180	34	6232	160	290	48
623112RS	55	120	-	1601501	75	115	13	632001	100	215	47	6332	160	340	68
431102	55	120	43	601501	75	115	20	61821	105	130	13	61834	170	215	22
641101	55	140	33	621501	75	130	25	61921	105	145	20	61934	170	230	28
61812	60	78	10	421502	75	130	31	1602101	105	160	18	16034	170	260	28
61912	60	85	13	631501	75	160	37	602101	105	160	26	6034	170	260	42
1601201	60	95	11	641501	75	190	45	622101	105	190	36	6234	170	310	52
601201	60	95	18	61816	80	100	10	632101	105	225	49	6334	170	360	72
630122RS	60	95	-	61916	80	110	16	61822	110	140	16	61836	180	225	22
621201	60	110	22	1601601	80	125	14	61922	110	150	20	61936	180	250	33
622122RS	60	110	-	601601	80	125	22	16022	110	170	19	16036	180	280	31
421202	60	110	28	621601	80	140	26	6022	110	170	28	6036	180	280	46
631201	60	130	31	421602	80	140	33	6222	110	200	38	6236	180	320	52
623122RS	60	130	-	631601	80	170	39	6322	110	240	50	6336	180	380	75
431202	60	130	46	641601	80	200	48	61824	120	150	16	61840	200	250	24
641201	60	150	35	61817	85	110	13	61924	120	165	22	61940	200	280	38
61813	65	85	10	61917	85	120	18	16024	120	180	19	16040	200	310	34
61913	65	90	13	1601701	85	130	14	6024	120	180	28	6040	200	310	51
1601301	65	100	11	601701	85	130	22	6224	120	215	40	6240	200	360	58
								6324	120	260	55	6340	200	420	80

DESMONTABLES

Modelo	d	D	B	Modelo	d	D	B	Modelo	d	D	B
E3	3	16	5	E10	10	28	8	L17	17	40	10
E4	4	16	5	E11	11	32	7	B017	17	44	11
E5	5	16	5	E12	12	32	7	E19	19	40	9
E6	6	21	7	E13	13	30	7	E20	20	47	12
E7	7	22	7	E14	14	35	8	L20	20	47	14
E8	8	24	7	E15	15	35	8	M20	20	52	15
E9	9	28	8	B015	15	40	10	L25	25	52	15
								M25	25	62	17

19012

RODAMIENTOS OSCILANTES DE DOS HILERAS DE BOLAS



Modelo	d	D	B
135	5	19	6
126	6	19	6
127	7	22	7
108	8	22	7
129	9	26	8
1200	10	20	9
2200	10	30	14
1201	12	32	10
2201	12	32	14
1301	12	37	12
2301	12	37	17
1202	15	35	11
2202	15	35	14
1302	15	42	13
2302	15	42	17
1203	17	40	12
2203	17	40	16

Modelo	d	D	B
1303	17	47	14
2303	17	47	19
1204	20	47	14
2204	20	47	18
1304	20	52	15
2304	20	52	21
1205	25	52	15
2205	25	52	18
1305	25	62	17
2305	25	62	24
1206	30	62	16
2206	30	62	20
1306	30	72	19
2306	30	72	27
1207	35	72	17
2207	35	72	23
1307	35	80	21
2307	35	80	31
1208	40	80	18
2208	40	80	23
1308	40	90	23
2308	40	90	33
1209	45	85	19
2209	45	85	23

Modelo	d	D	B
1309	45	100	25
2309	45	100	36
1210	50	90	20
2210	50	90	23
1310	50	110	27
2310	50	110	40
1211	55	100	21
2211	55	100	25
1311	55	120	29
2311	55	120	43
1212	60	110	22
2212	60	110	28
1312	60	130	31
2312	60	130	46
1213	65	120	23
2213	65	120	31
1313	65	140	33
2313	65	140	48
1214	70	125	24
2214	70	125	31
1314	70	150	35
2314	70	150	51
1215	75	130	25
2215	75	130	31
1315	75	160	37

Modelo	d	D	B
2315	75	160	55
1216	80	140	26
2216	80	140	33
1316	80	170	39
2316	80	170	58
1217	85	150	28
2217	85	150	36
1317	85	180	41
2317	85	180	60
1218	90	160	30
2218	90	160	40
1318	90	190	43
2318	90	190	64
1219	95	170	32
2219	95	170	43
1319	95	200	45
2319	95	200	67
1220	100	180	34
2220	100	180	46
1320	100	215	47
2320	100	215	73
1221	105	190	36
2221	105	190	50
1222	110	200	38
2222	110	200	53
1322	110	240	50

19013

RODAMIENTOS DE CONTACTO ANGULAR DE UNA Y DOS HILERAS DE BOLAS



01
1 hilera
de bolas



02
2 hileras
de bolas

Modelo	Nº hileras	d	D	B
7200B	01	10	30	9
3200	02	10	30	14
7201B	01	12	32	10
3201	02	12	32	15,9
7202B	01	15	35	11
3202	02	15	35	15,9
7302B	01	15	42	13
3302	02	15	42	19
7203B	01	17	40	12
3203	02	17	40	17,5
7303B	01	17	47	14
3303	02	17	47	22,2
7204B	01	20	47	14
3204	02	20	47	20,6
7304B	01	20	52	17
3304	02	20	52	25,4
7205B	01	25	52	15
3205	02	25	52	20,6
7305B	01	25	62	17
3305	02	25	62	25,4
7206B	01	30	62	16
3206	02	30	62	23,8
7306B	01	30	72	19
3306	02	30	72	30,2
7207B	01	35	72	17
3207	02	35	72	27
7307B	01	35	80	21
3307	02	35	80	34,9
7208B	01	40	80	18
3208	02	40	80	30,2

Modelo	Nº hileras	d	D	B
7308B	01	40	90	23
3308	02	40	90	36,5
7209B	01	45	85	19
3209	02	45	85	30,2
7309B	01	45	100	25
3309	02	45	100	39,7
7210B	01	50	90	20
3210	02	50	90	30,2
7310B	01	50	110	27
3310	02	50	110	44,4
7211B	01	55	100	21
3211	02	55	100	33,3
7311B	01	55	120	29
3311	02	55	120	49,2
7212B	01	60	110	22
3212	02	60	110	36,5
7312B	01	60	130	31
3312	02	60	130	54
7213B	01	65	120	23
3213	02	65	120	38,1
7313B	01	65	140	33
3313	02	65	140	58,7
7214B	01	70	125	24
3214	02	70	125	39,7
7314B	01	70	150	35
3314	02	70	150	63,5
7215B	01	75	130	25
3215	02	75	130	41,5
7315B	01	75	160	37
3315	02	75	160	68,3

Modelo	Nº hileras	d	D	B
7216B	01	80	140	26
3216	02	80	140	44,4
7316B	01	80	170	39
3316	02	80	170	68,3
7217B	01	85	150	28
3217	02	85	150	49,2
7317B	01	85	180	41
3317	02	85	180	73
7218B	01	90	160	30
3218	02	90	160	52,4
7318B	01	90	190	43
3318	02	90	190	73
7219B	01	95	170	32
3219	02	95	170	55,6
7319B	01	95	200	45
3319	02	95	200	77,8
7220B	01	100	180	34
3220	02	100	180	60,3
7320B	01	100	215	47
3320	02	100	215	82,6
7221B	01	105	190	36
7321B	01	105	225	49
7222B	01	110	200	38
3222	02	110	200	69,8
7322B	01	110	240	50
3322	02	110	240	92,1
7224B	01	120	215	40
7324B	01	120	260	55
7226B	01	130	230	40
7326B	01	130	280	58
7228B	01	140	250	42
7328B	01	140	300	62
7230	01	150	270	45
7330	01	150	320	65
732	01	160	290	48
7234	01	170	310	52
7334	01	170	360	72
7236	01	180	320	52

19014

RODAMIENTOS OSCILANTES DE RODILLOS ESFERICOS

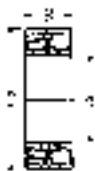

Modelo	d	D	B	Modelo	d	D	B	Modelo	d	D	B	Modelo	d	D	B
21304	20	52	15	21320	100	215	47	24134	170	280	109	24152	260	440	180
22205	25	52	18	22320	100	215	73	22234	170	310	86	22252	260	480	130
21305	25	62	17	23022	110	170	45	23234	170	310	110	23252	260	480	174
22206	30	62	20	23122	110	180	56	22334	170	360	120	22352	260	540	165
21306	30	72	19	24122	110	180	69	23936	180	250	52	23956	280	380	75
22207	35	72	23	22222	110	200	53	23036	180	280	74	23056	280	420	106
21307	35	80	21	23222	110	200	69,8	24036	180	280	100	24056	280	420	140
22208	40	80	23	21322	110	240	50	23136	180	300	96	23156	280	460	146
21308	40	90	23	22322	110	240	80	24136	180	300	118	24156	280	460	180
22308	40	90	33	23024	120	180	46	22236	180	320	86	22256	280	500	130
22209	45	85	23	24024	120	180	60	23236	180	320	112	23256	280	500	176
21309	45	100	25	23124	120	200	62	22336	180	380	126	22356	280	580	175
22309	45	100	36	24124	120	200	80	23038	190	290	75	23960	300	420	90
22210	50	90	23	22224	120	215	58	24038	190	290	100	23060	300	460	118
21310	50	110	27	23224	120	215	76	23138	190	320	104	24060	300	460	160
22310	50	110	40	22324	120	260	86	24138	190	320	128	23160	300	500	160
22211	55	100	25	23026	130	200	52	22238	190	340	92	24160	300	500	200
21311	55	120	29	24026	130	200	69	23238	190	340	120	22260	300	540	140
22311	55	120	43	23126	130	210	64	22338	190	400	132	23260	300	540	192
22212	60	110	28	24126	130	210	80	23940	200	280	60	23964	320	440	90
21312	60	130	31	22226	130	230	64	23040	200	310	82	23064	320	480	121
22312	60	130	46	23226	130	230	80	24040	200	310	109	24064	320	480	160
22213	65	120	31	22326	130	280	93	23140	200	340	112	23164	320	540	176
21313	65	140	33	23028	140	210	53	24140	200	340	140	24164	320	540	218
22313	65	140	48	24028	140	210	69	22240	200	360	98	22264	320	580	150
22214	70	125	31	23128	140	225	68	23240	200	360	128	23264	320	580	208
21314	70	150	35	24128	140	225	85	22340	200	420	138	23968	340	460	90
22314	70	150	51	22228	140	250	68	23944	220	300	60	23068	340	520	133
22215	75	130	31	23228	140	250	88	23044	220	340	90	24068	340	520	180
21315	75	160	37	22328	140	300	102	24044	220	340	118	23168	340	580	190
22315	75	160	55	23030	150	225	56	23144	220	370	120	24168	340	580	243
22216	80	140	33	24030	150	225	75	24144	220	370	150	23268	340	620	224
21316	80	170	39	23130	150	250	80	22244	220	400	108	23972	360	480	90
22316	80	170	58	24130	150	250	100	23244	220	400	144	23072	360	540	134
22217	85	150	36	22230	150	270	73	22344	220	460	145	24072	360	540	180
21317	85	180	41	23230	150	270	96	23948	240	320	60	23172	360	600	192
22317	85	180	60	22330	150	320	108	23048	240	360	92	24172	360	600	243
22218	90	160	40	23032	160	240	60	24048	240	360	118	23272	360	650	232
23218	90	160	52,4	24032	160	240	80	23148	240	400	128	23976	380	520	106
21318	90	190	43	23132	160	270	86	24148	240	400	160	23076	380	560	135
22318	90	190	64	24132	160	270	109	22248	240	440	120	24076	380	560	180
22219	95	170	43	22232	160	290	80	23248	240	440	160	23176	380	620	194
21319	95	200	45	23232	160	290	104	22348	240	500	155	24176	380	620	243
22319	95	200	67	22332	160	340	114	23952	260	360	75	23276	380	680	240
23120	100	165	52	23034	170	260	67	23052	260	400	104				
22220	100	180	46	24034	170	260	90	24052	260	400	140				
23220	100	180	60,3	23134	170	280	88	23152	260	440	144				

19015

RODAMIENTOS DE RODILLOS CILÍNDRICOS



Tipo NU

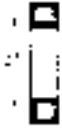

Tipo NJ

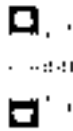

Tipo NUP



Tipo N

Tipo NU	Tipo NJ	Tipo NUP	Tipo N	d mm	D mm	B mm
NU202	NJ202			15	35	11
NU203	NJ203			17	40	12
NU2203	NJ2203	NUP2203		17	40	16
NU303	NJ303		N303	17	47	14
NU204	NJ204	NUP204	N204	20	47	14
NU2204	NJ2204	NUP2204		20	47	18
NU304	NJ304	NUP304	N304	20	52	15
NU2304	NJ2304	NUP2304		20	52	21
NU205	NJ205	NUP205	N205	25	52	15
NU2205	NJ2205	NUP2205		25	52	18
NU305	NJ305	NUP305	N305	25	62	17
NU2305	NJ2305	NUP2305		25	62	24
NU1006				30	55	13
NU206	NJ206	NUP206	N206	30	62	16
NU2206	NJ2206	NUP2206		30	62	20
NU306	NJ306	NUP306	N306	30	72	19
NU2306	NJ2306	NUP2306		30	72	27
NU406	NJ406			30	90	23
NU1007				35	62	14
NU207	NJ207	NUP207	N207	35	72	17
NU2207	NJ2207	NUP2207		35	72	23
NU307	NJ307	NUP307	N307	35	80	21
NU2307	NJ2307	NUP2307		35	80	31
NU407	NJ407			35	100	25
NU1008				40	68	15
NU208	NJ208	NUP208	N208	40	80	18
NU2208	NJ2208	NUP2208		40	80	23
NU308	NJ308	NUP308	N308	40	90	23
NU2308	NJ2308	NUP2308		40	90	33
NU408	NJ408			40	110	27
NU1009				45	75	16
NU209	NJ209	NUP209	N209	45	85	19
NU2209	NJ2209	NUP2209		45	85	23
NU309	NJ309	NUP309	N309	45	100	25
NU2309	NJ2309	NUP2309		45	100	36
NU409	NJ409			45	120	29
NU1010				50	80	16
NU210	NJ210	NUP210	N210	50	90	20
NU2210	NJ2210	NUP2210		50	90	23
NU310	NJ310	NUP310	N310	50	110	27
NU2310	NJ2310	NUP2310		50	110	40
NU410	NJ410			50	130	31
NU1011				55	90	18
NU211	NJ211	NUP211	N211	55	100	21
NU2211	NJ2211	NUP2211		55	100	25
NU311	NJ311	NUP311	N311	55	120	29
NU2311	NJ2311	NUP2311		55	120	43
NU411	NJ411			55	140	33
NU1012				60	95	18
NU212	NJ212	NUP212	N212	60	110	22
NU2212	NJ2212	NUP2212		60	110	28
NU312	NJ312	NUP312	N312	60	130	31
NU2312	NJ2312	NUP2312		60	130	46
NU412	NJ412			60	150	35
NU1013				65	100	18
NU213	NJ213	NUP213	N213	65	120	23
NU2213	NJ2213	NUP2213		65	120	31
NU313	NJ313	NUP313	N313	65	140	33
NU2313	NJ2313	NUP2313		65	140	48
NU413	NJ413			65	160	37
NU1014				70	110	20
NU214	NJ214	NUP214	N214	70	125	24
NU2214	NJ2214	NUP2214		70	125	31
NU314	NJ314	NUP314	N314	70	150	35
NU2314	NJ2314	NUP2314		70	150	51
NU414	NJ414			70	180	42

Tipo NU	Tipo NJ	Tipo NUP	Tipo N	d mm	D mm	B mm
NU1015				75	115	20
NU215	NJ215	NUP215	N215	75	130	24
NU2215	NJ2215	NUP2215		75	130	31
NU315	NJ315	NUP315	N315	75	160	35
NU2315	NJ2315	NUP2315		75	160	51
NU415	NJ415			75	190	42
NU1016				80	125	22
NU216	NJ216	NUP216	N216	80	140	26
NU2216	NJ2216	NUP2216		80	140	33
NU316	NJ316	NUP316	N316	80	170	39
NU2316	NJ2316	NUP2316		80	170	58
NU416	NJ416			80	200	48
NU1017				85	130	22
NU217	NJ217	NUP217	N217	85	150	28
NU2217	NJ2217	NUP2217		85	150	36
NU317	NJ317	NUP317	N317	85	180	41
NU2317	NJ2317	NUP2317		85	180	60
NU417	NJ417			85	210	52
NU1018				90	140	24
NU218	NJ218	NUP218	N218	90	160	30
NU2218	NJ2218	NUP2218		90	160	40
NU318	NJ318	NUP318	N318	90	190	43
NU2318	NJ2318	NUP2318		90	190	64
NU418	NJ418			90	225	54
NU1019				95	145	24
NU219	NJ219	NUP219	N219	95	170	32
NU2219	NJ2219	NUP2219		95	170	43
NU319	NJ319	NUP319	N319	95	200	45
NU2319	NJ2319	NUP2319		95	200	67
NU419	NJ419			95	240	55
NU1020				100	150	24
NU220	NJ220	NUP220	N220	100	180	34
NU2220	NJ2220			100	180	46
NU320	NJ320	NUP320	N320	100	215	47
NU2320	NJ2320	NUP2320		100	215	73
NU420	NJ420			100	250	58
NU1021				105	160	26
NU221	NJ221	NUP221	N221	105	190	36
NU321	NJ321	NUP321	N321	105	225	49
NU421				105	260	60
NU1022				110	170	28
NU222	NJ222	NUP222	N222	110	200	38
NU2222	NJ2222	NUP2222		110	200	53
NU322	NJ322	NUP322	N322	110	240	50
NU2322	NJ2322	NUP2322		110	240	80
NU422	NJ422			110	280	65
NU1024				120	180	28
NU224	NJ224	NUP224	N224	120	215	40
NU2224	NJ2224	NUP2224		120	215	58
NU324	NJ324	NUP324	N324	120	260	55
NU2324	NJ2324	NUP2324		120	260	86
NU424	NJ424			120	310	72
NU1026				130	200	33
NU226	NJ226	NUP226	N226	130	230	40
NU2226	NJ2226			130	230	64
NU326	NJ326	NUP326	N326	130	280	58
NU2326	NJ2326	NUP2326		130	280	93
NU1028				140	210	33
NU228	NJ228	NUP228	N228	140	250	42
NU2228	NJ2228	NUP2228		140	250	68
NU328	NJ328	NUP328		140	300	62
NU2328	NJ2328	NUP2328		140	300	102
NU1030				150	225	35
NU230	NJ230	NUP230	N230	150	270	45
NU2230				150	270	73
NU330	NJ330			150	320	65
NU2330	NJ2330			150	320	108

19 Rodamientos y cojinetes

Rodamientos de rodillos cónicos

19016

RODAMIENTOS DE RODILLOS CONICOS



Modelo	d	D	T
30202	15	35	11,75
30302	15	42	14,25
30203	17	40	13,25
30303	17	47	15,25
32303	17	47	20,25
32004x	20	42	15
32204	20	47	15,25
30304	20	52	16,25
32304	20	52	22,25
320/22x	22	44	15
32005x	25	47	15
32205	25	52	16,25
30305	25	52	19,25
32305	25	52	22
30305	25	62	18,25
31305	25	62	18,25
32305	25	62	25,25
320/25x	28	52	16
322/28B	28	58	20,25
32006x	30	55	17
30206	30	62	17,25
32206	30	62	21,25
33206	30	62	25
30306	30	72	20,75
31306	30	72	20,75
32306	30	72	28,75
320/32x	32	58	17
32007x	35	62	18
30207	35	72	18,25
32207	35	72	24,25
33207	35	72	28
30307	35	80	22,75
31307	35	80	22,75
32307	35	80	32,75
32008x	40	68	19
33108	40	75	26
30208	40	80	19,75
32208	40	80	24,75
33208	40	80	32
30308	40	90	25,25
31308	40	90	25,25
32308	40	90	35,25
32009x	45	75	20
33109	45	80	26
30209	45	85	20,75
32209	45	85	24,75
33209	45	85	32
30309	45	100	27,25
31309	45	100	27,25
32309	45	100	38,25

Modelo	d	D	T
32010x	50	80	20
33010	50	80	24
33110	50	85	26
30210	50	90	21,75
32210	50	90	24,75
33210	50	90	32
30310	50	110	29,25
31310	50	110	29,25
32310	50	110	42,25
32011x	55	90	23
33011	55	90	27
33111	55	95	30
30211	55	100	22,75
32211	55	100	26,75
33211	55	100	35
30311	55	120	31,50
31311	55	120	31,50
32311	55	120	45,50
32012x	60	95	23
33012	60	95	27
33112	60	100	30
30212	60	110	23,75
32212	60	110	29,75
33212	60	110	38
30312	60	130	33,50
31312	60	130	33,50
32312	60	130	48,50
32013x	65	100	23
33013	65	100	27
33113	65	110	34
30213	65	120	24,75
32213	65	120	32,75
33213	65	120	41
30313	65	140	36
31313	65	140	36
32313	65	140	51
32014x	70	110	25
33014	70	110	31
33114	70	120	37
30214	70	125	26,25
32214	70	125	33,25
33214	70	125	41
30314	70	150	38
31314	70	150	38
32314	70	150	54
32015x	75	115	25
33015	75	115	31
33115	75	125	37
30215	75	130	27,25
32215	75	130	33,25

Modelo	d	D	T
33215	75	130	41
30315	75	160	40
31315	75	160	40
32315	75	160	58
32016x	80	125	29
33016	80	125	36
33116	80	130	37
30216	80	140	28,25
32216	80	140	35,25
33216	80	140	46
30316	80	170	42,50
31316	80	170	42,50
32316	80	170	61,50
32017x	85	130	29
33017	85	130	36
33117	85	140	41
30217	85	150	30,50
32217	85	150	38,50
33217	85	150	49
30317	85	180	44,50
31317	85	180	44,50
32317	85	180	63,50
32018x	90	140	32
33018	90	140	39
33118	90	150	45
30218	90	160	32,50
32218	90	160	42,50
30318	90	190	46,50
31318	90	190	46,50
32318	90	190	67,50
32019x	95	145	32
33019	95	145	39
30219	95	170	34,50
32219	95	170	45,50
30319	95	200	49,50
31319	95	200	49,50
32319	95	200	71,50
32020x	100	150	32
33020	100	150	39
33120	100	180	37
30220	100	180	49
32220	100	180	63
30320	100	215	51,50
31320x	100	215	56,50
32320	100	215	77,50
32021x	105	160	35
33021	105	160	43
30221	105	190	39
32221	105	190	53
30321	105	225	53,50

Modelo	d	D	T
32321	105	225	81,50
32022x	110	170	38
33022	110	170	47
33122	110	180	56
30222	110	200	41
32222	110	200	56
30322x	110	240	54,50
31322	110	240	63
32322	110	240	84,50
32024x	120	180	38
33024	120	180	48
30224	120	215	43,50
32224	120	215	61,50
30324	120	260	59,50
31324x	120	260	68
32324	120	260	90,50
32026	130	200	45
30226	130	230	43,75
32226	130	230	67,75
30326	130	280	63,75
31326	130	280	72
32326	130	280	98,75
32028x	140	210	45
30228	140	250	45,75
32228	140	250	71,75
30328	140	300	67,75
31328x	140	300	77
32030	150	225	48
33030	150	225	59
30230	150	270	49
32230	150	270	77
30330	150	320	72
31330	150	320	82
32330	150	320	114
32032	160	240	51
30232	160	290	52
32232	160	290	84
30332	160	340	75
32034	170	260	57
30234	170	310	57
32234	170	310	91
30334	170	360	80
32036	180	280	64
30236	180	320	57
32236	180	320	91



19017

RODAMIENTOS AXIALES DE BOLAS

DE SIMPLE EFECTO

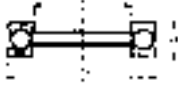

Modelo	d	D	H
51100	10	24	9
51200	10	26	11
2900	10	26	12
51101	12	26	9
51201	12	28	11
2901	12	28	12
51102	15	28	9
51202	15	32	12
2902	15	31	12
51103	17	30	9
51203	17	35	12
2903	18	35	12
51104	20	35	10
51204	20	37	12
2904	20	40	14
2904A	22	42	14
51105	25	42	11
2905	25	45	14
51205	25	47	15
9055	25	48	15,5
3905	25	52	16
51305	25	52	18
51405	25	60	24
51106	30	47	11
2906	30	50	14
51206	30	53	15,5
9056	30	52	16
3906	30	60	19
51306	30	60	21
51406	30	70	28
51107	35	52	12

Modelo	d	D	H
2907	35	55	16
51207	35	62	18
3907	35	68	22
51307	35	68	24
51407	35	80	32
51108	40	60	13
51208	40	68	19
3908	40	76	25
51308	40	78	26
51408	40	90	36
51109	45	65	14
2909	45	68	16
51209	45	73	20
909	45	73	22
51309	45	85	28
51409	45	100	39
51110	50	70	14
2910	50	74	18
51210	50	78	22
3910	50	92	31
51310	50	95	31
51410	50	110	43
51111	55	78	16
911	55	88	24,5
51211	55	90	25
51311	55	105	35
51411	55	120	48
2912	60	82	18
51112	60	85	17
912	60	90	24,5
51212	60	95	26

Modelo	d	D	H
3912	60	106	35
51312	60	110	35
51412	60	130	51
51113	65	90	18
2913	65	90	20
51213	65	100	27
3913	65	112	36
51313	65	115	36
51413	65	140	36
51114	70	95	18
2914	70	95	20
51214	70	103	27
3914	70	105	27
51314	70	125	40
51414	70	150	60
51115	75	100	19
51215	75	110	27
3915	75	128	41
51315	75	135	44
51415	75	160	65
51116	80	105	19
51216	80	115	28
3916	80	136	44
51316	80	140	44
51416	80	170	68
51117	85	110	19
51217	85	125	31
51317	85	150	49
51417	85	180	72
51118	90	120	22
51218	90	135	35
51318	90	155	50
51418	90	190	77
51120	100	135	25
51220	100	150	38
51320	100	170	55
51420	100	210	85
51122	110	145	25
51222	110	160	38
51322	110	190	63

Modelo	d	D	H
51422	110	230	95
51124	120	155	25
51224	120	170	39
51324	120	210	70
51424	120	250	102
51126	130	170	30
51226	130	190	45
51326	130	225	75
51426	130	270	110
51128	140	180	31
51228	140	200	46
51328	140	240	80
51130	150	190	31
51230	150	215	50
51330	150	250	80
51132	160	200	31
51232	160	225	51
51332	160	270	87
51134	170	215	34
51234	170	240	55
51334	170	280	87
51136	180	225	34
51236	180	250	56
51336	180	300	95
51138	190	240	37
51238	190	270	62
51338	190	320	105
51140	200	250	37
51240	200	280	62
51340	200	340	110
51144	220	270	37
51244	220	300	63
51148	240	300	45
51248	240	340	78
51152	260	320	45
51252	260	360	79
51156	280	350	53
51256	280	380	80
51160	300	380	62
51260	300	420	95

DE SIMPLE EFECTO CON ASIENTO ESFERICO

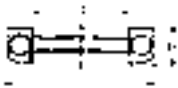

Roda- miento	Contra- placa	d mm	D mm	H mm
53202	U202	15	32	13,3
53203	U203	17	35	13,2
53204	U204	20	40	14,7
53205	U205	25	47	16,7
53206	U206	30	52	17,8
53306	U306	30	60	22,6
53207	U207	35	62	19,9
53307	U307	35	68	25,6
53208	U208	40	68	20,3
53308	U308	40	78	28,5
53408	U408	40	90	38,2
53209	U209	45	73	21,3

Roda- miento	Contra- placa	d mm	D mm	H mm
53309	U309	45	85	30,1
53210	U210	50	78	23,5
53310	U310	50	95	34,4
53410	U410	50	110	45,6
53211	U211	55	90	27,4
53311	U311	55	105	39,3
53411	U411	55	120	50,5
53212	U212	60	95	28
53312	U312	60	110	38,3
53412	U412	60	130	54
53213	U213	65	100	28,7
53313	U313	65	115	39,4
53214	U214	70	105	28,8
53314	U314	70	125	44,2
53414	U414	70	150	63,6
53215	U215	75	110	28,4
53315	U315	75	135	48,1

Roda- miento	Contra- placa	d mm	D mm	H mm
53415	U415	75	160	69
53216	U216	80	115	29,5
53316	U316	80	140	47,6
53416	U416	80	170	72,2
53217	U217	85	125	33,1
53317	U317	85	150	53,1
53218	U218	90	135	38,5
53318	U318	90	155	54,6
53220	U220	100	150	40,9
53320	U320	100	170	59,2
53420	U420	100	210	90
53222	U222	110	160	40,2
53322	U322	110	190	67,2
53224	U224	120	170	40,8
53324	U324	120	210	74,1
53226	U226	130	190	47,9
53228	U228	140	200	48,6

19 Rodamientos y cojinetes

Rodamientos axiales de bolas

19017

RODAMIENTOS AXIALES DE BOLAS

DE DOBLE EFECTO



Modelo	d	D	B
52202	10	32	22
52204	15	40	26
52205	20	47	28
52305	20	52	34
52406	20	70	52
52206	25	52	29
52306	25	60	38
52407	25	80	59

Modelo	d	D	B
52207	30	62	34
52208	30	68	36
52307	30	68	44
52308	30	78	49
52408	30	90	65
52209	35	73	37
52309	35	85	52
52409	35	100	72

Modelo	d	D	B
52210	40	78	39
52310	40	95	58
52410	40	110	78
52211	45	90	45
52311	45	105	64
52411	45	120	87
52212	50	95	46
52312	50	110	64
52412	50	130	93
52413	50	140	101
52213	55	100	47
52214	55	105	47
52313	55	115	65
52314	55	125	72
52215	60	110	47
52315	60	135	79
52216	65	115	48

Modelo	d	D	B
52316	65	140	79
52217	70	125	55
52317	70	150	87
52218	75	135	62
52318	75	155	88
52220	85	150	67
52320	85	170	97
52222	90	160	67
52322	90	190	110
52224	100	170	68
52324	100	210	123
52226	110	190	80
52228	120	200	81
52230	130	215	89
52330	130	250	140
52232	40	225	90
52234	150	240	97

DE DOBLE EFECTO CON ASIENTO ESFERICO



Roda- miento	Contra- placa	d mm	D mm	H mm
54204	U204	15	40	27,5
54205	U205	20	47	31,4
54305	U305	20	52	37,6
54206	U206	25	52	33,6
54306	U306	25	60	41,3

Roda- miento	Contra- placa	d mm	D mm	H mm
54207	U207	30	62	37,7
54208	U208	30	68	38,8
54307	U307	30	68	47,2
54308	U308	30	78	54,1
54209	U209	35	73	39,6
54309	U309	35	85	56,3
54210	U210	40	78	43
54310	U310	40	95	64,7
54410	U410	40	110	83,2

Roda- miento	Contra- placa	d mm	D mm	H mm
54211	U211	45	90	49,7
54311	U311	45	105	72,6
54312	U312	50	110	70,7
54314	U314	55	125	80,3
54315	U315	60	135	87,2
54316	U316	65	140	86,1
54317	U317	70	150	95,2
54420	U420	80	210	159,9

19018

RODAMIENTOS AXIALES DE RODILLOS

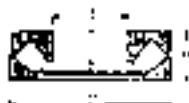

Modelo	d	D	B
29412	60	130	42
29413	65	140	45
29414	70	150	48
29415	75	160	51
29416	80	170	54
29317	85	150	39
29417	85	180	58
29318	90	155	39
29418	90	190	60
29320	100	170	42
29420	100	210	67

Modelo	d	D	B
29322	110	190	48
29422	110	230	73
29324	120	210	54
29424	120	250	78
29326	130	225	58
29426	130	270	85
29328	140	240	60
29428	140	280	85
29330	150	250	60
29430	150	300	90
29332	160	270	67

Modelo	d	D	B
29432	160	320	95
29334	170	280	67
29434	170	340	103
29336	180	300	73
29436	180	360	109
29338	190	320	78
29438	190	380	115
29240	200	280	48
29340	200	340	85
29440	200	400	122
29244	220	300	48
29344	220	360	85
29444	220	420	122
29248	240	340	60
29348	240	380	85
29448	240	440	122

Modelo	d	D	B
29252	260	360	60
29352	260	420	95
29452	260	480	132
29256	280	380	60
29356	280	440	95
29456	280	520	145
29260	300	420	73
29360	300	480	109
29460	300	540	145
29264	320	440	73
29364	320	500	109
29464	320	580	155
29268	340	460	73
29368	340	540	122
29468	340	620	170



19019

SOportes PARA RODAMIENTOS A BOLAS

DE APOYO



SERIE PASE...

Fundición gris, anillo tensor y obturación P

SERIE PASEY...

Fundición gris, tornillos prisioneros en el anillo interior y obturación P

Modelo	Modelo	d mm	W mm	H mm
PASE 12	PASEY 12	12	125	57
PASE 15	PASEY 15	15	125	57
PASE 17	PASEY 17	17	125	57
PASE 20	PASEY 20	20	130	64
PASE 25	PASEY 25	25	130	70
PASE 30	PASEY 30	30	158	82
PASE 35	PASEY 35	35	163	93
PASE 40	PASEY 40	40	179	99
PASE 45	PASEY 45	45	192	107
PASE 50	PASEY 50	50	200	115
PASE 55	-	55	222	124,5
PASE 60	PASEY 60	60	240	140

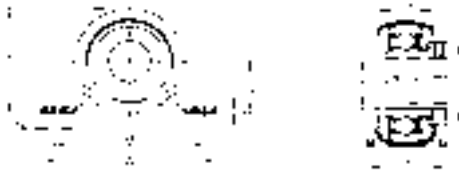

SERIE PB...

Chapa de acero, anillo tensor y obturación P

SERIE PBY...

Chapa de acero, tornillos prisioneros en el anillo interior y obturación P

Modelo	Modelo	d mm	W mm	H mm
PB 12	PBY 12	12	85,7	43,2
PB 15	PBY 15	15	85,7	43,2
PB 17	PBY 17	17	85,7	43,2
PB 20	PBY 20	20	98,4	50,1
PB 25	PBY 25	25	108	56,5
PB 30	PBY 30	30	117,5	66,1

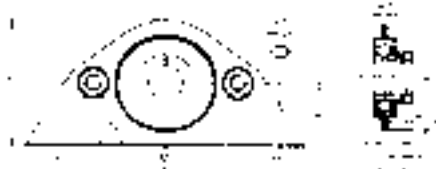

SERIE PBS...

Chapa de acero, anillo tensor y obturación P

Modelo	d mm	W mm	H mm
PBS 12	12	123,8	59,6
PBS 15	15	123,8	59,6
PBS 17	17	123,8	59,6
PBS 20	20	127	66,8
PBS 25	25	133,5	72
PBS 30	30	159	85
PBS 35	35	165	94,4
PBS 40	40	180	106



SERIE PSHE...

Fundición gris, anillo tensor y obturación P

SERIE PSHEY...

Fundición gris, tornillos prisioneros en el anillo interior y obturación P

Modelo	Modelo	d mm	W mm	H mm
PSHE 12	PSHEY 12	12	63	57
PSHE 15	PSHEY 15	15	63	57
PSHE 17	PSHEY 17	17	63	57
PSHE 20	PSHEY 20	20	65	64
PSHE 25	PSHEY 25	25	70	70
PSHE 30	PSHEY 30	30	98	82
PSHE 35	PSHEY 35	35	103	93
PSHE 40	PSHEY 40	40	116	99
PSHE 45	PSHEY 45	45	120	107
PSHE 50	PSHEY 50	50	135	115
PSHE 55	-	55	150	125
PSHE 60	PSHEY 60	60	150	140

19019

SOportes PARA RODAMIENTOS A BOLAS



DE APOYO



SERIE RASE...

Fundición gris, anillo tensor y obturación R

SERIE RASEY...

Fundición gris con recubrimiento Corrotect, anillo tensor y obturación R

Modelo	d mm	W mm	H mm
RASE 17	17	125	57
RASE 20	20	130	64
RASE 25	25	130	70
RASE 30	30	158	82
RASE 35	35	163	93
RASE 40	40	179	99
RASE 45	45	192	107
RASE 50	50	200	115
RASE 55I	55	222	124,5
RASE 60	60	240	140
RASE 65S	65	260	156
RASE 70S	70	260	156
RASE 75S	75	265	164
RASE 80	80	290	175
RASE 90	90	330	200
RASE 100	100	380	225
RASE 120	120	440	265

Modelo	d mm	W mm	H mm
RASEY 12	12	125	57
RASEY 15	15	125	57
RASEY 16	16	125	57
RASEY 17	12	125	57
RASEY 20	20	130	64
RASEY 25	25	130	70
RASEY 30	30	158	82
RASEY 35	35	163	93
RASEY 40	40	179	99
RASEY 45	45	192	107
RASEY 50	50	200	115
RASEY 55I	55	222	124,5
RASEY 60	60	240	140
RASEY 65S	65	260	156
RASEY 70S	70	260	156
RASEY 75S	75	265	164
RASEY 80	80	290	175
RASEY 90	90	330	200

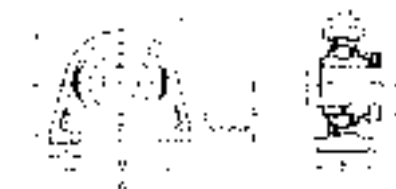

SERIE RSHE...

Fundición gris, anillo tensor y obturación R

SERIE RSHEY...

Fundición gris, tornillos prisioneros en el anillo interior y obturación R

Modelo	Modelo	d mm	W mm	H mm
-	RSHEY 12	12	63	57
-	RSHEY 15	15	63	57
RSHE 17	RSHEY 17	17	63	57
RSHE 20	RSHEY 20	20	65	64
RSHE 25	RSHEY 25	25	70	70
RSHE 30	RSHEY 30	30	98	82
RSHE 35	RSHEY 35	35	103	93
RSHE 40	RSHEY 40	40	116	99
RSHE 45	RSHEY 45	45	120	107
RSHE 50	RSHEY 50	50	135	115
RSHE 55	RSHEY 55	55	150	125
RSHE 60	RSHEY 60	60	150	140



SERIE TASE...

Fundición gris, anillo tensor y obturación P3

Modelo	d mm	W mm	H mm
TASE 20	20	130	64
TASE 25	25	130	70
TASE 30	30	158	82
TASE 35	35	163	93
TASE 40	40	179	99
TASE 45	45	192	107
TASE 50	50	200	115
TASE 55I	55	222	124,5
TASE 60	60	240	140
TASE 65	65	260	156
TASE 70	70	260	156
TASE 75	75	265	164
TASE 80	80	290	175

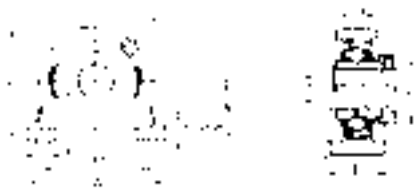

SERIE TSHE...

Fundición gris, anillo tensor y obturación P3

Modelo	d mm	W mm	H mm
TSHE 20	20	65	64
TSHE 25	25	70	70
TSHE 30	30	98	82
TSHE 35	35	103	93
TSHE 40	40	116	99
TSHE 45	45	120	107
TSHE 50	50	135	115
TSHE 55	55	150	125
TSHE 60	60	150	140

BRIDA DOS AGUJEROS

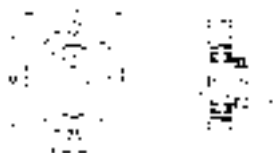

SERIE FLCTE...

Fundición gris, anillo tensor y obturación P

SERIE FLCTEY...

Fundición gris, tornillos prisioneros en el anillo interior y obturación P

Modelo	d mm	B mm	U mm
FLCTE 12	12	81	30,5
FLCTE 15	15	81	30,5
FLCTE 17	17	81	30,5
FLCTE 20	20	90,5	33
FLCTE 25	25	97	33,4
FLCTE 30	30	112,5	38,1
FLCTE 35	35	126	41,8
FLCTE 40	40	150	46,2

Modelo	d mm	B mm	U mm
FLCTEY 12	12	81	26
FLCTEY 15	15	81	26
FLCTEY 17	17	81	26
FLCTEY 20	20	90,5	27
FLCTEY 25	25	97	29,4
FLCTEY 30	30	112,5	32,4
FLCTEY 35	35	126	37,9
FLCTEY 40	40	150	42,5

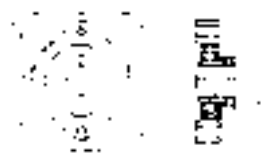

SERIE GLCTE...

Fundición gris, anillo tensor y obturación P

Modelo	d mm	B mm	U mm
GLCTE 12	12	81	30,5
GLCTE 15	15	81	30,5
GLCTE 17	17	81	30,5
GLCTE 20	20	90,5	33
GLCTE 25	25	97	33,4
GLCTE 30	30	112,5	38,1
GLCTE 35	35	126	41,8
GLCTE 40	40	150	46,2

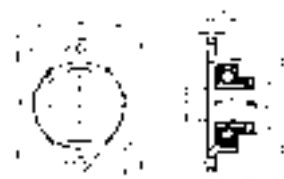

SERIE PCFT...

Fundición gris, anillo tensor y obturación P

Modelo	d mm	B mm	U mm
PCFT 12	12	99	32,1
PCFT 15	15	99	32,1
PCFT 17	17	99	32,1
PCFT 20	20	112	34
PCFT 25	25	124	36
PCFT 30	30	142	40
PCFT 35	35	155	44,9
PCFT 40	40	172	51
PCFT 45	45	180	51,9
PCFT 50	50	190	51,9

19019

SOportes PARA RODAMIENTOS A BOLAS



BRIDA DOS AGUJEROS



SERIE PCJT...

Fundición gris, anillo tensor y obturación P

SERIE PCJTY...

Fundición gris, tornillos prisioneros en el anillo interior y obturación P

Modelo	d mm	W mm	H mm
PCJT 15	15	99	39,1
PCJT 17	17	99	39,1
PCJT 20	20	112	42,5
PCJT 25	25	124	42,5
PCJT 30	30	142	46,7
PCJT 35	35	155	50,4
PCJT 40	40	172	56,7
PCJT 45	45	180	56,7
PCJT 50	50	190	60,7
PCJT 55	55	222	67,4
PCJT 60	60	238	73,6

Modelo	d mm	W mm	H mm
PCJTY 12	12	99	33
PCJTY 15	15	99	33
PCJTY 17	17	99	33
PCJTY 20	20	112	37
PCJTY 25	25	124	38,5
PCJTY 30	30	142	41
PCJTY 35	35	155	46,5
PCJTY 40	40	172	53
PCJTY 45	45	180	54,5
PCJTY 50	50	190	60
PCJTY 60	60	200	238



SERIE RAT...

Chapa de acero, anillo tensor y obturación P

SERIE RATY...

Chapa de acero, tornillos prisioneros en el anillo interior y obturación P

Modelo	d mm	B mm	U mm
RAT 12	12	81	24
RAT 15	15	81	24
RAT 17	17	81	24
RAT 20	20	90,5	25,5
RAT 25	25	97	25,5
RAT 30	30	112,7	29,2
RAT 35	35	123	31,5
RAT 40	40	148	36,2

Modelo	d mm	B mm	U mm
RATY 12	12	81	18
RATY 15	15	81	18
RATY 17	17	81	18
RATY 20	20	90,5	20
RATY 25	25	95,2	21,5
RATY 30	30	112,5	23,5
RATY 35	35	123	28
RATY 40	40	148	32,5



SERIE RCJT...

Fundición gris, anillo tensor y obturación R

SERIE RCJT...FA125

Fundición gris con recubrimiento Corrotect, anillo tensor y obturación R

Modelo	d mm	B mm	U mm
RCJT 17	17	99	39,1
RCJT 20	20	112	45,6
RCJT 25	25	124	45,9
RCJT 30	30	142	50,1
RCJT 35	35	155	53,3
RCJT 40	40	172	58,9
RCJT 45	45	180	58,9
RCJT 50I	50	190	66,1
RCJT 55	55	222	74,6
RCJT 60	60	238	80
RCJT 65S	65	258	82,6
RCJT 70S	70	258	82,6
RCJT 75S	75	258	83,6

Modelo	d mm	B mm	U mm
RCJT 20 FA125	20	112	45,6
RCJT 25 FA125	25	124	45,9
RCJT 30 FA125	30	142	50,1
RCJT 35 FA125	35	155	53,3
RCJT 40 FA125	40	172	58,9
RCJT 50 FA125	50	190	66,1



SERIE RCJTY...

Fundición gris, tornillos prisioneros en el anillo interior y obturación R

Modelo	d mm	B mm	U mm
RCJTY 12	12	99	32,9
RCJTY 15	15	99	32,9
RCJTY 16	16	99	32,9
RCJTY 17	17	99	32,9
RCJTY 20	20	112	37,3
RCJTY 25	25	124	38,7
RCJTY 30	30	142	42,2
RCJTY 35	35	155	46,4
RCJTY 40	40	172	54,2
RCJTY 45	45	180	54,2
RCJTY 50	50	190	60,6
RCJTY 55	55	222	64,4
RCJTY 60	60	238	73,7
RCJTY 65	65	258	82,4
RCJTY 70	70	258	82,4
RCJTY 75	75	258	82,5



SERIE RCJTZ...

Fundición gris, con resalte de centrado, anillo tensor y obturación P

Modelo	d mm	B mm	U mm
RCJTZ 20	20	112,5	45,6
RCJTZ 25	25	124	45,9
RCJTZ 30	30	142	47,1
RCJTZ 35	35	155	49,3
RCJTZ 40	40	172	54,9
RCJTZ 45	45	180	54,9
RCJTZ 50	50	190	62,1
RCJTZ 60	60	238	76,8



SERIE RCSMF...

Chapa de acero, cubierta de goma, anillo tensor y obturación P

Modelo	d mm	B mm	U mm
RCSMF 12	12	114	34,8
RCSMF 15	15	114	34,8
RCSMF 17	17	114	34,8
RCSMF 20	20	114	36,2
RCSMF 25	25	114	36,2
RCSMF 30	30	114	35



SERIE TCJT...

Fundición gris, tornillos prisioneros en el anillo interior y obturación P3

Modelo	d mm	B mm	U mm
TCJT 20	20	112	45,6
TCJT 25	25	124	45,9
TCJT 30	30	142	50,1
TCJT 35	35	155	53,3
TCJT 40	40	172	58,9
TCJT 45	45	180	58,9
TCJT 50I	50	190	66,1
TCJT 55	55	222	74,6
TCJT 65	65	258	82,6
TCJT 70	70	258	82,6
TCJT 75	75	258	83,6

19019

SOportes PARA RODAMIENTOS A BOLAS

DE TRES Y CUATRO AGUJEROS

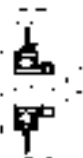
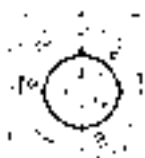

SERIE GRA...

Chapa de acero, anillo tensor y obturación P



SERIE PCCJ...

Fundición gris, anillo tensor y obturación P



SERIE PCF...

Fundición gris, anillo tensor y obturación P



SERIE PCFTR...

Fundición gris, anillo tensor y obturación P

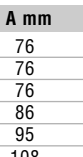
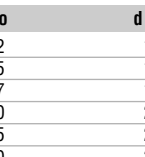

SERIE PCJ...

Fundición gris, anillo tensor y obturación P

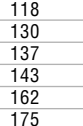
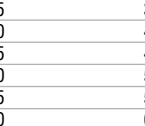

SERIE PCJY...

Fundición gris, tornillos prisioneros en el anillo interior y obturación P

Modelo	d mm	A mm	L mm
GRA 20	20	90,5	31
GRA 25	25	95	31
GRA 30	30	112,7	35,7
GRA 35	35	122	38,9
GRA 40	40	147,5	43,7
GRA 45	45	149,2	43,7
GRA 50	50	155,5	43,7

SERIE PCCJ...

Fundición gris, con centrado, de dos hileras, obturación P

Modelo	d mm	A mm	L mm
PCCJ 25	25	95	30
PCCJ 30	30	108	34
PCCJ 40	40	130	38

Modelo	d mm	A mm	L mm
PCF 20	20	86	34
PCF 25	25	95	36
PCF 30	30	108	40
PCF 35	35	118	44,9
PCF 40	40	130	51
PCF 45	45	137	51,9
PCF 50	50	143	51,4

Modelo	d mm	A mm	L mm
PCFTR 12	12	81	32,1
PCFTR 15	15	81	32,1
PCFTR 17	17	81	32,1
PCFTR 20	20	92	34
PCFTR 25	25	97	36
PCFTR 30	30	117	40
PCFTR 35	35	128	45,1
PCFTR 40	40	137	51
PCFTR 45	45	150	51,9
PCFTR 50	50	150	51,9

Modelo	d mm	A mm	L mm
PCJ 12	12	76	39,1
PCJ 15	15	76	39,1
PCJ 17	17	76	39,1
PCJ 20	20	86	42,5
PCJ 25	25	95	42,5
PCJ 30	30	108	46,7
PCJ 35	35	118	50,4
PCJ 40	40	130	56,7
PCJ 45	45	137	56,7
PCJ 50	50	143	60,7
PCJ 55	55	162	67,4
PCJ 60	60	175	73,6

Modelo	d mm	A mm	L mm
PCJY 12	12	76	33
PCJY 15	15	76	33
PCJY 17	17	76	33
PCJY 20	20	86	37
PCJY 25	25	95	38,5
PCJY 30	30	108	41
PCJY 35	35	118	46,5
PCJY 40	40	130	53
PCJY 45	45	137	54,5
PCJY 50	50	143	60
PCJY 60	60	175	68



SERIE PME...

Fundición gris, con resalte de centraje, anillo tensor y obturación P

SERIE PMEX...

Fundición gris, tornillos prisioneros en el anillo interior y obturación P

Modelo	d mm	A mm	L mm
PME 20	20	100	31
PME 25	25	115	31
PME 30	30	125	35,7
PME 35	35	135	38,9
PME 40	40	145	43,7
PME 45	45	155	43,7
PME 50	50	165	43,7
PME 55	55	185	48,4
PME 60	60	195	53,1

Modelo	d mm	A mm	L mm
PMEY 20	20	100	25
PMEY 25	25	115	27
PMEY 30	30	125	30
PMEY 35	35	135	35
PMEY 40	40	145	39,5
PMEY 45	45	155	41,5
PMEY 50	50	165	43
PMEY 60	60	195	47

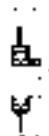
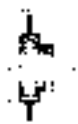

SERIE RA...

Chapa de acero, anillo tensor y obturación P

SERIE RAY...

Chapa de acero, tornillos prisioneros en el anillo interior y obturación P

Modelo	d mm	A mm	L mm
RA 12	12	81	28,6
RA 15	15	81	28,6
RA 17	17	81	28,6
RA 20	20	90,5	31
RA 25	25	95	31
RA 30	30	112,7	35,7
RA 35	35	122	38,9
RA 40	40	147,5	43,7
RA 45	45	149,2	43,7
RA 50	50	155,5	43,7

Modelo	d mm	A mm	L mm
RAY 12	12	81	22
RAY 15	15	81	22
RAY 17	17	81	22
RAY 20	20	90,5	25
RAY 25	25	95	27
RAY 30	30	112,7	30
RAY 35	35	122	35



SERIE RATR...

Chapa de acero, anillo tensor y obturación P

SERIE RATRY...

Chapa de acero, tornillos prisioneros en el anillo interior y obturación P

Modelo	d mm	A mm	L mm
RATR 20	20	90,5	31
RATR 25	25	95,3	31
RATR 30	30	112,7	35,7
RATR 35	35	127	38,9

Modelo	d mm	A mm	L mm
RATRY 30	30	112,7	30
RATRY 35	35	127	35



SERIE RFE...

Fundición gris, con resalte de centraje, anillo tensor y obturación R

SERIE RTFE...

Fundición gris, tornillos prisioneros en el anillo interior y obturación P3

Modelo	d mm	A mm	L mm
RFE 25	25	115	44,4
RFE 30	30	127	48,4
RFE 35	35	135	51,1
RFE 40	40	145	56,3
RFE 45	45	155	56,3
RFE 50	50	165	62,7
RFE 60	60	195	77,8

Modelo	d mm	A mm	L mm
TFE 25	25	115	44,4
TFE 30	30	127	48,4
TFE 35	35	135	51,1
TFE 40	40	145	56,3
TFE 45	45	155	56,3
TFE 50	50	165	62,7

19019

SOportes PARA RODAMIENTOS A BOLAS

DE TRES Y CUATRO AGUJEROS



SERIE RCJ...

Fundición gris, anillo tensor y obturación R

SERIE RCJY...

Fundición gris, tornillos prisioneros en el anillo interior y obturación R

Modelo	d mm	A mm	U mm
RCJ 17	17	76	40,4
RCJ 20	20	86	45,6
RCJ 25	25	95	45,9
RCJ 30	30	108	50,1
RCJ 35	35	118	53,3
RCJ 40	40	130	58,9
RCJ 45	45	137	58,9
RCJ 50I	50	143	66,1
RCJ 55	55	162	74,6
RCJ 60	60	175	80,8
RCJ 65S	65	188	82,6
RCJ 70S	70	188	82,6
RCJ 75S	75	197	86,9
RCJ 80	80	197	88,9
RCJ 90	90	235	70,3
RCJ 100	100	265	77,5
RCJ 120	120	305	83

Modelo	d mm	A mm	U mm
RCJY 12	12	76	32,9
RCJY 15	15	76	32,9
RCJY 16	16	76	32,9
RCJY 17	17	76	32,5
RCJY 20	20	86	37,3
RCJY 25	25	95	38,8
RCJY 30	30	108	42,2
RCJY 35	35	118	46,4
RCJY 40	40	130	54,2
RCJY 45	45	137	54,2
RCJY 50I	50	143	60,6
RCJY 55	55	162	64,4
RCJY 60	60	175	73,7
RCJY 65-213	65	187	69,7
RCJY 65	65	188	82,4
RCJY 70	70	188	82,4
RCJY 75	75	197	85,8
RCJY 80	80	197	90,6
RCJY 90	90	235	80,1

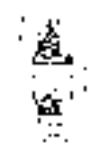

SERIE RME...

SERIE RMEY...

Modelo	d mm	A mm	L mm
RME 20	20	100	43,7
RME 25	25	115	44,4
RME 30	30	125	48,4
RME 35	35	135	51,1
RME 40	40	145	56,3
RME 45	45	155	56,3
RME 50	50	165	62,7
RME 55	55	185	71,4
RME 60	60	195	77,8
RME 65S	65	215	66,1
RME 70S	70	215	66,1
RME 75S	75	220	67,1
RME 80	80	220	71
RME 90	90	265	69,5
RME 100	100	295	75
RME 120	120	350	81

Modelo	d mm	A mm	L mm
RME 20	20	100	31
RME 25	25	115	34,1
RME 30	30	125	38,1
RME 35	35	135	42,9
RME 40	40	145	49,2
RME 45	45	155	49,2
RME 50	50	165	51,6
RME 55	55	185	55,6
RME 60	60	195	65,1
RME 65-213	65	205	65,1
RME 65	65	215	74,6
RME 70	70	215	74,6
RME 75	75	220	77,8
RME 80	80	220	82,6
RME 90	90	265	96



SERIE TCJ...

Fundición gris, anillo tensor y obturación P3



SERIE TME...

Fundición gris, con resalte de centrado, anillo tensor y obturación P3

TENSORES

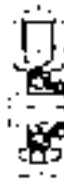

Modelo	d mm	A mm	M mm
PHE 20	20	91	65
PHE 25	25	99	70
PHE 30	30	114	85
PHE 35	35	122	90
PHE 40	40	135	100
PHE 45	45	145	110
PHE 50	50	145	110

Modelo	d mm	A mm	U mm
TCJ 20	20	86	45,6
TCJ 25	25	95	45,9
TCJ 30	30	108	50,1
TCJ 35	35	118	53,3
TCJ 40	40	130	58,9
TCJ 45	45	137	58,9
TCJ 50l	50	143	66,1
TCJ 55	55	162	74,6
TCJ 60	60	175	80,8
TCJ 65	65	188	82,6
TCJ 70	70	188	82,6
TCJ 75	75	197	86,9
TCJ 80	80	197	88,9

Modelo	d mm	A mm	L mm
RME 20	20	100	43,7
RME 25	25	115	44,4
RME 30	30	125	48,4
RME 35	35	135	51,1
RME 40	40	145	56,3
RME 45	45	155	56,3
RME 50	50	165	62,7
RME 55	55	185	71,4
RME 60	60	195	77,8
RME 65	65	215	66,1
RME 70	70	215	66,1
RME 75	75	220	67,1
RME 80	80	220	71

SERIE PHE...

Fundición gris, anillo tensor y obturación P

SERIE PHEY...

Fundición gris, tornillos prisioneros en el anillo interior y obturación P

Modelo	d mm	A mm	M mm
PHEY 20	20	91	65
PHEY 25	25	99	70
PHEY 30	30	114	85
PHEY 35	35	122	90
PHEY 40	40	135	100
PHEY 45	45	145	110

SERIE PHUSE...

Fundición gris, anillo tensor y obturación P

Modelo	d mm	B mm	E mm
PHUSE 25	25	22	4
PHUSE 30	30	22	4
PHUSE 35	35	22	4
PHUSE 40	40	30	4
PHUSE 50	50	30	4



SERIE PSFT...

Fundición gris, anillo tensor y obturación P

Modelo	d mm	A mm	U mm
PSFT 20	20	112	34
PSFT 25	25	124	36
PSFT 30	30	142	39,7
PSFT 35	35	155	44,5

19019

SOportes PARA RODAMIENTOS A BOLAS



TENSORES



Modelo	d mm	A mm	V mm
PTUE 20	20	94,5	90
PTUE 25	25	98,5	90
PTUE 30	30	114,5	102
PTUE 35	35	131,5	102
PTUE 40	40	141	115
PTUE 45	45	141	115
PTUE 50	50	148	115
PTUE 55	55	169	145
PTUE 60	60	486	146

SERIE PTUE...

Fundición gris, anillo tensor y obturación P

SERIE PTUEY...

Fundición gris, tornillos prisioneros en el anillo interior y obturación P

Modelo	d mm	A mm	V mm
PTUEY 20	20	94,5	90
PTUEY 25	25	98,5	90
PTUEY 30	30	114,5	102
PTUEY 50	50	148	115
PTUEY 60	60	486	146



SERIE RHE...

Fundición gris, anillo tensor y obturación R

Modelo	d mm	A mm	M mm
RHE 20	20	91	65
RHE 25	25	99	70
RHE 30	30	114	85
RHE 35	35	122	90
RHE 40	40	135	100
RHE 45	45	145	110
RHE 50	50	145	110



SERIE RTUE...

Fundición gris, anillo tensor y obturación R

SERIE RTUEO...

Fundición gris, anillo tensor y obturación R

SERIE RTUEY...

Fundición gris, tornillos prisioneros en el anillo interior y obturación R

Modelo	d mm	A mm	V mm
RTUE 20	20	94,5	90
RTUE 25	25	98,5	90
RTUE 30	30	114,5	102
RTUE 35	35	131,5	102
RTUE 40	40	141	115
RTUE 45	45	141	115
RTUE 50	50	148	115
RTUE 55	55	169	145
RTUE 60	60	186	146
RTUE 65S	65	214	166
RTUE 70S	70	214	166
RTUE 75S	75	214	166
RTUE 80	80	230	184
RTUE 90	90	275	215
RTUE 100	100	295	240
RTUE 120	120	345	285

Modelo	d mm	A mm	V mm
RTUEO 80S	80	282	230
RTUEO 90S	90	312	255
RTUEO 100S	100	345	290

Modelo	d mm	A mm	V mm
RTUEY 20	20	94,5	90
RTUEY 25	25	98,5	90
RTUEY 30	30	114,5	102
RTUEY 35	35	131,5	102
RTUEY 40	40	141	115
RTUEY 50	50	148	115
RTUEY 60	60	186	146
RTUEY 65S	65	214	166
RTUEY 70S	70	214	166
RTUEY 75S	75	214	166
RTUEY 80	80	230	184

19020

RODAMIENTOS AUTOALINEABLES

CON SUPERFICIE CILINDRICA DEL ANILLO EXTERIOR



SERIE 2..KRR(AH..)



**SERIE RAE..NPP
SERIE RALE..NPP**

Modelo	d mm	D mm	L mm
203 KRR AH05	13	40	18,3
202 KRR	15	35	14,4
203 KRR AH02	16	40	18,3
203 KRR	17	40	18,3
204 KRR	20	47	17,7
205 KRR	25	52	21
206 KRR	30	62	24
208 KRR	40	80	27
209 KRR	45	85	30
210 KRR	50	90	30
211 KRR	55	100	36
212 KRR	60	110	36

Modelo	d mm	D mm	L mm
RAE 12 NPP	12	40	28,6
RAE 15 NPP	15	40	28,6
RAE 17 NPP	17	40	28,6
RAE 20 NPP	20	47	31
RAE 25 NPP	25	52	31
RAE 30 NPP	30	62	35,7
RAE 35 NPP	35	72	38,9
RAE 40 NPP	40	80	43,7
RAE 45 NPP	45	85	43,7
RAE 50 NPP	50	90	43,7
RAE 60 NPP	60	110	53,1

Modelo	d mm	D mm	L mm
RALE 20 NPP	20	42	24,6
RALE 25 NPP	25	47	25,4
RALE 30 NPP	30	55	26,5



SERIE RAE..NPP NR

Modelo	d mm	D mm	L mm
RAE 20 NPP NR	20	47	31
RAE 25 NPP NR	25	52	31
RAE 30 NPP NR	30	62	35,7
RAE 35 NPP NR	35	72	38,9
RAE 40 NPP NR	40	80	43,7

CON SUPERFICIE ESFERICA DEL ANILLO EXTERIOR

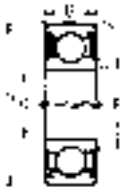

SERIE 2..NPPB

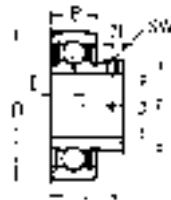

SERIE AY..NPPB

Modelo	d mm	D mm	L mm
201 NPPB	12	32	10
203 NPPB	17	40	12
204 NPPB	20	47	14
205 NPPB	25	52	15
206 NPPB	30	62	16
207 NPPB	35	72	17
208 NPPB	40	80	18
209 NPPB	45	85	19
210 NPPB	50	90	20

Modelo	d mm	D mm	L mm
AY 12 NPPB	12	40	22
AY 15 NPPB	15	40	22
AY 17 NPPB	17	40	22
AY 20 NPPB	20	47	25
AY 25 NPPB	25	52	27
AY 30 NPPB	30	62	30

19020

RODAMIENTOS AUTOALINEABLES



CON SUPERFICIE ESFERICA DEL ANILLO EXTERIOR



SERIE GAY..NPPB

Modelo	d mm	D mm	L mm
GAY 12 NPPB	12	40	22
GAY 15 NPPB	15	40	22
GAY 17 NPPB	17	40	22
GAY 20 NPPB	20	47	25
GAY 25 NPPB	25	52	27
GAY 30 NPPB	30	62	30
GAY 35 NPPB	35	72	35
GAY 40 NPPB	40	80	39,5
GAY 45 NPPB	45	85	41,5
GAY 50 NPPB	50	90	43
GAY 60 NPPB	60	110	47

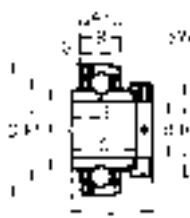

SERIE GE..KLLHB

Con anillo tensor excéntrico

Modelo	d mm	D mm	L mm
GE 20 KLLHB	20	47	43,7
GE 25 KLLHB	25	52	44,4
GE 30 KLLHB	30	62	48,4
GE 35 KLLHB	35	72	51,1
GE 40 KLLHB	40	80	56,3
GE 45 KLLHB	45	85	56,3
GE 50 KLLHB	50	90	62,7



SERIE GE..KPPB3

Con anillo tensor excéntrico

Modelo	d mm	D mm	L mm
GE 20 KPPB3	20	47	43,7
GE 25 KPPB3	25	52	44,4
GE 30 KPPB3	30	62	48,4
GE 35 KPPB3	35	72	51,1
GE 40 KPPB3	40	80	56,3
GE 45 KPPB3	45	85	56,3
GE 50 KPPB3	50	90	62,7
GE 55 KPPB3	55	100	71,4
GE 60 KPPB3	60	110	77,8
GE 65 KPPB3	65	125	66,1
GE 70 KPPB3	70	125	66,1
GE 75 KPPB3	75	130	67,1
GE 80 KPPB3	80	140	71



SERIE GE..KPPB(S)

Con anillo tensor excéntrico

Modelo	d mm	D mm	B mm
GE 17 KPPB	17	40	37,3
GE 20 KPPB	20	47	43,7
GE 25 KPPB	25	52	44,4
GE 30 KPPB	30	62	48,4
GE 35 KPPB	35	72	51,1
GE 40 KPPB	40	80	56,3
GE 45 KPPB	45	85	56,3
GE 50 KPPB	50	90	62,7
GE 55 KPPB	55	100	71,4
GE 60 KPPB	60	110	77,8
GE 65 KPPB	65	125	66,1
GE 70 KPPB	70	125	66,1
GE 75 KPPB	75	130	67,1
GE 80 KPPB	80	140	71
GE 90 KPPB	90	160	69,5
GE 100 KPPB	100	180	75
GE 110 KPPB	110	215	81



SERIE GE..KPPB3

Con anillo tensor excéntrico

Modelo	d mm	D mm	L mm
GLE 20 KRRB	20	47	34,1
GLE 25 KRRB	25	52	34,9
GLE 30 KRRB	30	62	36,5
GLE 35 KRRB	35	72	37,7
GLE 40 KRRB	40	80	42,9
GLE 45 KRRB	45	85	42,9
GLE 50 KRRB	50	90	49,2
GLE 60 KRRB	60	110	61,9
GLE 70 KRRB	70	125	68,2



SERIE GNE..KRRB(S)

Modelo	d mm	D mm	L mm
GNE 30 KRRB	30	72	50
GNE 35 KRRB	35	80	51,6
GNE 40 KRRB	40	90	54,6
GNE 50 KRRB	50	110	66,7
GNE 60 KRRB	60	130	68,4
GNE 70 KRRB	70	150	75,4
GNE 80 KRRBS	80	170	93,7
GNE 90 KRRBS	90	190	101
GNE 100 KRRBS	100	215	109,5

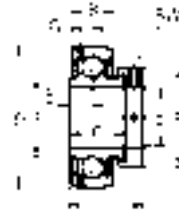

SERIE GRAE..NPPB
Con anillo tensor excéntrico

Modelo	d mm	D mm	L mm
GRAE 12 NPPB	12	40	28,6
GRAE 15 NPPB	15	40	28,6
GRAE 17 NPPB	17	40	28,6
GRAE 20 NPPB	20	47	31
GRAE 25 NPPB	25	52	31
GRAE 30 NPPB	30	62	35,7
GRAE 35 NPPB	35	72	38,9
GRAE 40 NPPB	40	80	43,7
GRAE 45 NPPB	45	85	43,7
GRAE 50 NPPB	50	90	43,7
GRAE 55 NPPB	55	100	48,4
GRAE 60 NPPB	60	110	53,1



SERIE GSH..RRB

Modelo	d mm	D mm	L mm
GSH 20 RRB	20	47	28
GSH 25 RRB	25	52	28
GSH 30 RRB	30	62	32
GSH 35 RRB	35	72	34
GSH 40 RRB	40	80	38



SERIE GYE..KRRB

Modelo	d mm	D mm	L mm
GYE 12 KRRB	12	40	27,4
GYE 15 KRRB	15	40	27,4
GYE 16 KRRB	16	40	27,4
GYE 17 KRRB	17	40	27,4
GYE 20 KRRB	20	47	31
GYE 25 KRRB	25	52	34,1
GYE 30 KRRB	30	62	38,1
GYE 35 KRRB	35	72	42,9
GYE 40 KRRB	40	80	49,2
GYE 45 KRRB	45	85	49,2
GYE 50 KRRB	50	90	51,6
GYE 55 KRRB	55	100	55,6
GYE 60 KRRB	60	110	65,1
GYE 65 KRRB-213	65	120	65,1
GYE 65 KRRB	65	125	74,6
GYE 70 KRRB	70	125	74,6
GYE 75 KRRB	75	130	77,8
GYE 80 KRRB	80	140	82,6
GYE 90 KRRB	90	160	96

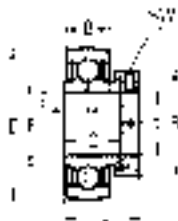

Con anillo tensor excéntrico

SERIE RAE..NPPB
SERIE RALE..NPPB

Modelo	d mm	D mm	L mm
RAE 12 NPPB	12	40	28,6
RAE 15 NPPB	15	40	28,6
RAE 17 NPPB	17	40	28,6
RAE 20 NPPB	20	47	31
RAE 25 NPPB	25	52	31
RAE 30 NPPB	30	62	35,7
RAE 35 NPPB	35	72	38,9
RAE 40 NPPB	40	80	43,7
RAE 50 NPPB	50	90	43,7
RALE 20 NPPB	20	42	24,6
RALE 25 NPPB	25	47	25,4
RALE 30 NPPB	30	55	26,5

19020

RODAMIENTOS AUTOALINEABLES

CON CUBIERTA DE GOMA



SERIE CR-B...



SERIE RABR...

Modelo	d mm	D mm	U mm
CR-B 20/76	20	77,5	36
CR-B 20/83	20	83,6	36,2
CR-B 25/70	25	71,5	36
CR-B 25/72	25	73	36
CR-B 25/83	25	83,6	36,2
CR-B 30/83	30	83,6	40,7
CR-B 30/92	30	93	40,7
CR-B 35/110	35	112,3	44,4

Modelo	d mm	D mm	U mm
RABR-B 12/47	12	47,6	30,9
RABR-B 20/52	20	52,3	32,3
RABR-B 25/62	25	62,2	33,9
RABR-A 30/62	30	62,2	33,9
RABR-B 30/72	30	72,2	38,2
RABR-B 35/80	35	80,2	41,4
RABR-B 40/85	40	85	46,7
RABR-B 50/100	50	100,2	47,7



SERIE RCR...



SERIE RCSM...

Modelo	d mm	D mm	U mm
RCR-A 20/46	20	46	24,6
RCR-B 25/57	25	56,9	31

Modelo	d mm	D mm	U mm
RCSM-B 15/65	15	65,1	28,6
RCSM-B 17/65	17	65,1	28,6
RCSM-B 20/65	20	65,1	31
RCSM-B 25/65	25	65,1	31
RCSM-A 30/65	30	65,1	26,5

19021

ANILLOS AUTOALINEABLES DE ACERO



SERIE BE...



SERIE PE...

Modelo	d mm	D mm	B mm
BE 20	20	55	16
BE 25	25	62	17
BE 30	30	72	21
BE 35	35	80	21
BE 40	40	90	25

Modelo	d mm	D mm	B mm
PE 20	20	55	31,5
PE 25	25	62	32
PE 30	30	72	37,2
PE 35	35	80	39,9
PE 40	40	90	45,2

19022

RODILLOS DE APOYO

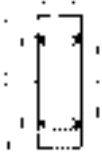

SERIE RSTO...
Sin guía axial

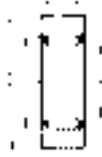

SERIE STO...
Sin guía axial

Modelo	Fw mm	D mm	C mm
RSTO 5 TN	7	16	7,8
RSTO 6 TN	10	19	9,8
RSTO 8 TN	12	24	9,8
RSTO 10	14	30	11,8
RSTO 12	16	32	11,8
RSTO 15	20	35	11,8
RSTO 17	22	40	15,8
RSTO 20	25	47	15,8
RSTO 25	30	52	15,8
RSTO 30	35	62	19,8

Modelo	d mm	D mm	B mm
STO 6 TN	6	19	10
STO 8 TN	8	24	10
STO 10	10	30	12
STO 12	12	32	12
STO 15	15	35	12
STO 17	17	40	16
STO 20	20	47	16
STO 25	25	52	16
STO 30	30	62	20

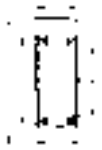

SERIE RNA 22..2RS
Sin guía axial. Obturados



SERIE RNA 22..2RS
Sin guía axial. Obturados

Modelo	Fw mm	D mm	C mm
RNA 22/6 2RS	10	19	11,8
RNA 22/8 2RS	12	24	11,8
RNA 2200 2RS	14	30	13,8
RNA 2201 2RS	16	32	13,8
RNA 2202 2RS	20	35	13,8
RNA 2203 2RS	22	40	15,8
RNA 2204 2RS	25	47	17,8
RNA 2205 2RS	30	52	17,8
RNA 2206 2RS	35	62	19,8

Modelo	d mm	D mm	B mm
NA 22/6 2RS	6	19	12
NA 22/8 2RS	8	24	12
NA 2200 2RS	10	30	14
NA 2201 2RS	12	32	14
NA 2202 2RS	15	35	14
NA 2203 2RS	17	40	16
NA 2204 2RS	20	47	18
NA 2205 2RS	25	52	18
NA 2206 2RS	30	62	20



SERIE NATR...
Con guía axial



SERIE NATR...PP
Con guía axial
Con obturación de labio

Modelo	Modelo	d mm	D mm	B mm
NATR 5	NATR 5 PP	5	16	12
NATR 6	NATR 6 PP	6	19	12
NATR 8	NATR 8 PP	8	24	15
NATR 10	NATR 10 PP	10	30	15
NATR 12	NATR 12 PP	12	32	15
NATR 15	NATR 15 PP	15	35	19
NATR 17	NATR 17 PP	17	40	21
NATR 20	NATR 20 PP	20	47	25
NATR 25	NATR 25 PP	25	52	25
NATR 30	NATR 30 PP	30	62	29



SERIE NATV...
Con guía axial

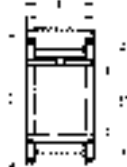

SERIE NATV...PP
Con guía axial
Con obturación de labio

Modelo	Modelo	d mm	D mm	B mm
NATV 5	NATV 5 PP	5	16	12
NATV 6	NATV 6 PP	6	19	12
NATV 8	NATV 8 PP	8	24	15
NATV 10	NATV 10 PP	10	30	15
NATV 12	NATV 12 PP	12	32	15
NATV 15	NATV 15 PP	15	35	19
NATV 17	NATV 17 PP	17	40	21
NATV 20	NATV 20 PP	20	47	25
NATV 25	NATV 25 PP	25	52	25
NATV 30	NATV 30 PP	30	62	29

19022

RODILLOS DE APOYO

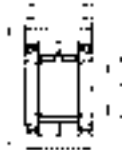

SERIE NUTR...
Con guía axial

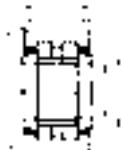

SERIE PWTR...2RS
Con guía axial
Obturados por ambos lados

Modelo	d mm	D mm	B mm
NUTR 15	15	35	19
NUTR 1542	15	42	19
NUTR 17	17	40	21
NUTR 1747	17	47	21
NUTR 20	20	47	25
NUTR 2052	20	52	25
NUTR 25	25	52	25
NUTR 2562	25	62	29
NUTR 30	30	62	29
NUTR 3072	30	72	29
NUTR 35	35	72	29
NUTR 3580	35	80	32
NUTR 40	40	80	32
NUTR 4090	40	90	32
NUTR 45	45	85	32
NUTR 45100	45	100	32
NUTR 50110	50	90	32
NUTR 50	50	110	32

Modelo	d mm	D mm	B mm
PWTR 15 2RS	15	35	19
PWTR 1542 2RS	15	42	19
PWTR 17 2RS	17	40	21
PWTR 1747 2RS	17	47	21
PWTR 20 2RS	20	47	25
PWTR 2052 2RS	20	52	25
PWTR 25 2RS	25	52	25
PWTR 2562 2RS	25	62	29
PWTR 30 2RS	30	62	29
PWTR 3072 2RS	30	72	29
PWTR 35 2RS	35	72	29
PWTR 3580 2RS	35	80	32
PWTR 40 2RS	40	80	32
PWTR 4090 2RS	40	90	32
PWTR 45 2RS	45	85	32
PWTR 45100 2RS	45	100	32
PWTR 50110 2RS	50	90	32
PWTR 50 2RS	50	110	32

19023

RODILLOS DE LEVAS



SERIE KR...



SERIE KR...PP
Con obturación de labio

Modelo	Modelo	D mm	d mm	B mm
KR 16	KR 16 PP	16	6	28
KR 19	KR 19 PP	19	8	32
KR 22	KR 22 PP	22	10	36
KR 26	KR 26 PP	26	10	36
KR 30	KR 30 PP	30	12	40
KR 32	KR 32 PP	32	12	40
KR 35	KR 35 PP	35	16	52
KR 40	KR 40 PP	40	18	58
KR 47	KR 47 PP	47	20	66
KR 52	KR 52 PP	52	20	66
KR 62	KR 62 PP	62	24	80
-	KR 72 PP	72	24	80
-	KR 80 PP	80	30	100
-	KR 90 PP	90	30	100



SERIE KRE...PP

Modelo	D mm	d1 mm	B mm
KRE 16 PP	16	9	28
KRE 19 PP	19	11	32
KRE 22 PP	22	13	36
KRE 26 PP	26	13	36
KRE 30 PP	30	15	40
KRE 32 PP	32	15	40
KRE 35 PP	35	20	52
KRE 40 PP	40	22	58
KRE 47 PP	47	24	66
KRE 52 PP	52	24	66
KRE 62 PP	62	28	80



SERIE KRV...PP
Sin jaula

Modelo	D mm	d1 mm	B mm
KRV 16 PP	16	6	28
KRV 19 PP	19	8	32
KRV 22 PP	22	10	36
KRV 26 PP	26	10	36
KRV 30 PP	30	12	40
KRV 32 PP	32	12	40
KRV 35 PP	35	16	52
KRV 40 PP	40	18	58
KRV 62 PP	62	24	80
KRV 72 PP	72	24	80
KRV 80 PP	80	30	100
KRV 90 PP	90	30	100



SERIE NUKR...

Modelo	D mm	d mm	B mm
NUKR 35	35	16	52
NUKR 40	40	18	58
NUKR 47	47	20	66
NUKR 52	52	20	66
NUKR 62	62	24	80
NUKR 72	72	24	80
NUKR 80	80	30	100
NUKR 90	90	30	100



SERIE NUKRE...

Modelo	D mm	d1 mm	B mm
NUKRE 35	35	20	52
NUKRE 40	40	22	58
NUKRE 47	47	24	66
NUKRE 52	52	24	66
NUKRE 62	62	28	80
NUKRE 72	72	28	80
NUKRE 80	80	35	100
NUKRE 90	90	35	100



SERIE PWKR...

Modelo	D mm	d mm	B mm
PWKR 35	35	16	52
PWKR 40	40	18	58
PWKR 47	47	20	66
PWKR 52	52	20	66
PWKR 62	62	24	80
PWKR 72	72	24	80
PWKR 80	80	30	100
PWKR 90	90	30	100



SERIE PWKRE...2RS

Modelo	D mm	d1 mm	B mm
PWKRE 35 2RS	35	20	52
PWKRE 40 2RS	40	22	58
PWKRE 47 2RS	47	24	66
PWKRE 52 2RS	52	24	66
PWKRE 62 2RS	62	28	80
PWKRE 72 2RS	72	28	80
PWKRE 80 2RS	80	35	100
PWKRE 90 2RS	90	35	100

19024

CORONAS DE AGUJAS

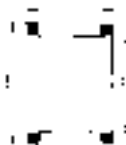

SERIE K

Modelo	Ø eje mm	Fw mm	Ew mm	B mm
K3x5x7 TN	3	3	5	7
K3x5x7 TN	3	3	5	9
K4x7x7 TN	4	4	7	7
K5x8x8 TN	5	5	8	8
K5x8x10 TN	5	5	8	10
K6x9x8 TN	6	6	9	8
K6x9x10 TN	6	6	9	10
K7x9x7 TN	7	7	9	7
K7x10x8 TN	7	7	10	8
K7x10x10 TN	7	7	10	10
K8x11x8 TN	8	8	11	8
K8x11x10 TN	8	8	11	10
K8x11x13 TN	8	8	11	13
K8x12x10 TN	8	8	12	10
K10x13x10 TN	10	10	13	10
K10x13x13 TN	10	10	13	13
K10x14x10 TN	10	10	14	10
K10x14x13 TN	10	10	14	13
K10x16x12 TN	10	10	16	12
K12x15x10 TN	12	12	15	10
K12x15x13 TN	12	12	15	13
K12x16x13 TN	12	12	16	13
K12x17x13 TN	12	12	17	13
K12x18x12 TN	12	12	19	12
K15x19x10	15	15	19	10
K15x19x13	15	15	19	13
K15x19x17	15	15	19	17
K15x21x15	15	15	21	15
K15x21x21	15	15	21	21
K16x20x10	16	16	20	10
K16x20x13	16	16	20	13
K16x20x17	16	16	20	17
K16x22x12	16	16	22	12
K16x22x20	16	16	22	20
K17x21x13	17	17	21	13
K18x22x17	18	18	22	17
K18x24x12	18	18	24	12
K18x24x20	18	18	24	20
K18x25x22	18	18	25	22
K19x23x13	19	19	23	13
K19x23x17	19	19	23	17

Modelo	Ø eje mm	Fw mm	Ew mm	B mm
K20x24x17	20	20	24	17
K20x26x12	20	20	26	12
K20x26x13	20	20	26	13
K20x26x17	20	20	26	17
K20x26x20	20	20	26	20
K20x28x20	20	20	28	20
K20x28x25	20	20	28	25
K20x30x30	20	20	30	30
K22x26x10	22	22	26	10
K22x26x13	22	22	26	13
K22x28x17	22	22	28	17
K22x30x16	22	22	30	16
K22x30x15 TN	22	22	30	15
K24x28x10	24	24	28	10
K25x29x10	25	25	29	10
K25x29x13	25	25	29	13
K25x29x17	25	25	29	17
K25x30x20	25	25	30	20
K25x31x17	25	25	31	17
K25x31x21	25	25	31	21
K25x32x16	25	25	32	16
K25x33x20	25	25	33	20
K25x33x24	25	25	33	24
K25x35x30	25	25	35	30
K26x30x17	26	26	30	17
K28x33x13	28	28	33	13
K28x33x17	28	28	33	17
K28x35x16	28	28	35	16
K28x35x18	28	28	35	17
K30x35x13	30	30	35	13
K30x35x17	30	30	35	17
K30x35x27	30	30	35	27
K30x37x16	30	30	37	16
K30x37x18	30	30	37	18
K30x40x30	30	30	40	30
K32x37x13	32	32	37	13
K32x37x27	32	32	37	27
K32x38x20	32	32	38	20
K32x39x16	32	32	39	16
K32x40x25	32	32	40	25
K35x40x13	35	35	40	13
K35x40x17	35	35	40	17
K35x40x27 TN	35	35	40	27

19025

RODAMIENTOS DE AGUJAS

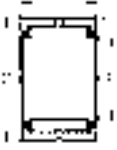

SERIE NK...

Sin anillo interior

Modelo	Fw mm	d mm	C mm
NK 5/10 TN	5	10	10
NK 5/12 TN	5	10	12
NK 6/10 TN	6	12	10
NK 6/12 TN	6	12	12
NK 7/10 TN	7	14	10
NK 8/12 TN	8	15	12
NK 8/12 TN	8	15	12
NK 9/16 TN	8	16	16
NK 9/12 TN	8	16	12
NK 10/12 TN	10	17	12
NK 10/16 TN	10	17	16
NK 12/12	12	19	12
NK 12/16	12	19	16
NK 14/16	14	22	16
NK 14/20	14	22	20
NK 15/16	15	23	16
NK 15/20	15	23	20
NK 16/16	16	24	16
NK 16/20	16	24	20
NK 17/16	17	25	16
NK 17/20	17	25	20
NK 18/16	18	26	16

Modelo	Fw mm	d mm	C mm
NK 18/20	18	26	20
NK 19/16	19	27	16
NK 19/20	19	27	20
NK 20/16	20	28	16
NK 20/20	20	28	20
NK 21/16	21	29	16
NK 21/20	21	29	20
NK 22/16	22	30	16
NK 22/20	22	30	20
NK 24/16	24	32	16
NK 24/20	24	32	20
NK 25/16	25	33	16
NK 25/20	25	33	20
NK 26/16	26	34	16
NK 26/20	26	34	20
NK 28/20	28	37	20
NK 28/30	28	37	30
NK 29/20	29	38	20
NK 30/20	30	40	20
NK 30/30	30	40	30
NK 32/20	32	42	20
NK 32/30	32	42	30
NK 35/20	35	45	20
NK 35/30	35	45	30
NK 37/20	37	47	20
NK 38/20	38	48	20
NK 40/20	40	50	20
NK 40/30	40	50	30
NK 42/20	42	52	20
NK 42/30	42	52	30

Modelo	Fw mm	d mm	C mm
NK 43/20	43	53	20
NK 45/20	45	55	20
NK 45/30	45	55	30
NK 47/20	47	57	20
NK 50/25	50	62	25
NK 50/35	50	62	35
NK 55/25	55	68	25
NK 55/35	55	68	35
NK 60/25	60	72	25
NK 60/35	60	72	35
NK 65/25	65	78	25
NK 65/35	65	78	35
NK 68/25	68	82	25
NK 68/35	68	82	35
NK 70/25	70	85	25
NK 70/35	70	85	35
NK 73/25	73	90	25
NK 80/25	80	95	25
NK 80/35	80	95	35
NK 85/25	85	105	25
NK 85/35	85	105	35
NK 90/25	90	110	25
NK 90/35	90	110	35
NK 95/26	95	115	26
NK 95/36	95	115	36
NK 100/26	100	120	26
NK 100/36	100	120	36
NK 105/26	105	125	26
NK 110/30	110	130	30
NK 110/40	110	130	40

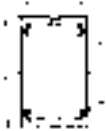

SERIE RNA 49...

SERIE RNA 69...

Modelo	Fw mm	d mm	C mm
RNA 4900	14	22	13
RNA 4901	16	24	13
RNA 4902	20	28	13
RNA 4903	22	30	13
RNA 4904	25	37	17
RNA 49/22	28	39	17
RNA 4905	30	42	17
RNA 49/28	32	45	17
RNA 4906	35	47	17
RNA 49/32	40	52	20
RNA 4907	42	55	20
RNA 4908	48	62	22
RNA 4909	52	68	22
RNA 4910	58	72	22

Modelo	Fw mm	d mm	C mm
RNA 4911	63	80	25
RNA 4912	68	85	25
RNA 4913	72	90	25
RNA 4914	80	100	30
RNA 4915	85	105	30
RNA 4916	90	110	30
RNA 4917	100	120	35
RNA 4918	105	125	35
RNA 4919	110	130	35
RNA 4920	115	140	40
RNA 4922	125	150	40
RNA 4924	135	165	45
RNA 4926	150	180	50
RNA 4928	160	190	50

Modelo	Fw mm	d mm	C mm
RNA 6901	16	24	22
RNA 6902	20	28	23
RNA 6903	22	30	23
RNA 6904	25	37	30
RNA 69/22	28	39	30
RNA 6905	30	42	30
RNA 69/28	32	45	30
RNA 6906	35	47	30
RNA 69/32	40	52	36
RNA 6907	42	55	36
RNA 6908	48	62	40
RNA 6909	52	68	40
RNA 6910	58	72	40

19025

RODAMIENTOS DE AGUJAS



SERIE RNA...RS

Con obturadores



SERIE RNA...2RS

Con dos obturadores

Modelo	Modelo	Fw mm	D mm	C mm
RNA 4900 RS	RNA 4900 2RS	14	22	13
RNA 4901 RS	RNA 4901 2RS	16	24	13
RNA 4902 RS	RNA 4902 2RS	20	28	13
RNA 4903 RS	RNA 4903 2RS	22	30	13
RNA 4904 RS	RNA 4904 2RS	25	37	17
RNA 4905 RS	RNA 4905 2RS	30	42	17
RNA 4906 RS	RNA 4906 2RS	35	47	17
RNA 4907 RS	RNA 4907 2RS	42	55	20
RNA 4908 RS	RNA 4908 2RS	48	62	22
RNA 4909 RS	RNA 4909 2RS	52	68	22
RNA 4910 RS	RNA 4910 2RS	58	72	22



SERIE NKI...

Con anillo interior

Modelo	Fw mm	D mm	C mm
NKI 5/12 TN	5	15	12
NKI 5/16 TN	5	15	16
NKI 6/12 TN	6	16	12
NKI 6/16 TN	6	16	16
NKI 7/12 TN	7	17	12
NKI 7/16 TN	7	17	16
NKI 9/12	9	19	12
NKI 9/16	9	19	16
NKI 10/16	10	22	16
NKI 10/20	10	22	20
NKI 12/16	12	24	16
NKI 12/20	12	24	20
NKI 15/16	15	27	16
NKI 15/20	15	27	20
NKI 17/16	17	29	16

Modelo	Fw mm	D mm	C mm
NKI 17/20	17	29	20
NKI 20/16	20	32	16
NKI 20/20	20	32	20
NKI 22/16	22	34	16
NKI 22/20	22	34	20
NKI 25/20	25	38	20
NKI 25/30	25	38	30
NKI 28/20	28	42	20
NKI 28/30	28	42	30
NKI 30/20	30	45	20
NKI 30/30	30	45	30
NKI 32/20	32	47	20
NKI 32/30	32	47	30
NKI 35/20	35	50	20
NKI 35/30	35	50	30
NKI 38/20	38	53	20
NKI 38/30	38	53	30
NKI 40/20	40	55	20
NKI 40/30	40	55	30
NKI 42/20	42	57	20
NKI 42/30	42	57	30
NKI 45/25	45	62	25
NKI 45/35	45	62	35

Modelo	Fw mm	D mm	C mm
NKI 50/25	50	68	25
NKI 50/35	50	68	35
NKI 55/25	55	72	25
NKI 55/35	55	72	35
NKI 60/25	60	82	25
NKI 60/35	60	82	35
NKI 65/25	65	90	25
NKI 65/35	65	90	35
NKI 70/25	70	95	25
NKI 70/35	70	95	35
NKI 75/25	75	105	25
NKI 75/35	75	105	35
NKI 80/25	80	110	25
NKI 80/35	80	110	35
NKI 85/26	85	115	26
NKI 85/36	85	115	36
NKI 90/26	90	120	26
NKI 90/36	90	120	36
NKI 95/26	95	125	26
NKI 95/36	95	125	36
NKI 100/30	100	130	30
NKI 100/40	100	130	40



SERIE NA 49...

Con anillo interior

Modelo	Fw mm	D mm	C mm
NA 4900	10	22	13
NA 4901	12	24	13
NA 4902	15	28	13
NA 4903	17	30	13
NA 4904	20	37	17
NA 49/22	22	39	17
NA 4905	25	42	17
NA 49/28	28	45	17
NA 4906	30	47	17
NA 49/32	32	52	20
NA 4907	35	55	20

Modelo	Fw mm	D mm	C mm
NA 4908	40	62	22
NA 4909	45	68	22
NA 4910	50	72	22
NA 4911	55	80	25
NA 4912	60	85	25
NA 4913	65	90	25
NA 4914	70	100	30
NA 4915	75	105	30
NA 4916	80	110	30
NA 4917	85	120	35
NA 4918	90	125	35



SERIE NA 49...RS

Obturados por un lado
Con anillo interior



SERIE NA 49...2RS

Obturados por ambos lados
Con anillo interior

Modelo	Modelo	Fw mm	D mm	C mm
NA 4900 RS	NA 4900 2RS	10	22	14
NA 4901 RS	NA 4901 2RS	12	24	14
NA 4902 RS	NA 4902 2RS	15	28	14
NA 4903 RS	NA 4903 2RS	17	30	14
NA 4904 RS	NA 4904 2RS	20	37	18
NA 4905 RS	NA 4905 2RS	25	42	18
NA 4906 RS	NA 4906 2RS	30	47	18
NA 4907 RS	NA 4907 2RS	35	55	21
NA 4908 RS	NA 4908 2RS	40	62	23
NA 4909 RS	NA 4909 2RS	45	68	23
NA 4910 RS	NA 4910 2RS	50	72	23



19026

RODAMIENTOS DE AGUJAS AUTOALINEABLES



SERIE RPNA...
Sin anillo interior



SERIE PNA...
Con anillo interior

Modelo	Fw mm	D mm	C mm
RPNA 15/28	15	28	12
RPNA 18/32	18	32	16
RPNA 20/35	20	35	16
RPNA 25/42	25	42	20
RPNA 30/47	30	47	20
RPNA 35/52	35	52	20
RPNA 40/55	40	55	20
RPNA 45/62	45	62	20

Modelo	Fw mm	D mm	C mm
PNA 12/28	12	28	12
PNA 15/32	15	32	16
PNA 17/35	17	35	16
PNA 20/42	20	42	20
PNA 25/47	25	47	20
PNA 30/52	30	52	20
PNA 35/55	35	55	20
PNA 40/62	40	62	20

19027

ANILLOS INTERIORES DE RODAMIENTOS DE AGUJAS



SERIE IR...

Modelo	d mm	F mm	B mm
IR 6x9x12	6	8	12
IR 6x10x10	6	10	10
IR 6x10x12	6	10	12
IR 7x10x10,5	7	10	10,5
IR 7x10x12	7	10	12
IR 8x12x10	8	12	10
IR 8x12x10,5	8	12	10,5
IR 8x12x12	8	12	12
IR 8x12x12,5	8	12	12,5
IR 9x12x12	9	12	12
IR 9x12x16	9	12	16
IR 10x13x12,5	10	13	12,5
IR 10x14x12	10	14	12
IR 10x14x13	10	14	13
IR 10x14x14	10	14	14
IR 10x14x16	10	14	16
IR 10x14x20	10	14	20
IR 12x15x12	12	15	12
IR 12x15x12,5	12	15	12,5
IR 12x15x16	12	15	16
IR 12x15x16,5	12	15	16,5
IR 12x15x22,5	12	15	22,5
IR 12x16x12	12	16	12
IR 12x16x13	12	16	13
IR 12x16x14	12	16	14
IR 12x16x16	12	16	16
IR 12x16x20	12	16	20
IR 12x16x22	12	16	22
IR 14x17x17	14	17	17
IR 15x18x16	15	18	16
IR 15x18x16,5	15	18	16,5
IR 15x19x20	15	19	20

Modelo	d mm	F mm	B mm
IR 15x20x13	15	20	13
IR 15x20x14	15	20	14
IR 15x20x23	15	20	23
IR 17x20x16	17	20	16
IR 17x20x16,5	17	20	16,5
IR 17x20x20	17	20	20
IR 17x20x20,5	17	20	20,5
IR 17x20x30,5	17	20	30,5
IR 17x21x20	17	21	20
IR 17x22x13	17	22	13
IR 17x22x16	17	22	16
IR 17x22x23	17	22	23
IR 20x24x16	20	24	16
IR 20x24x20	20	24	20
IR 20x25x16	20	25	16
IR 20x25x17	20	25	17
IR 20x25x20	20	25	20
IR 20x25x20,5	20	25	20,5
IR 20x25x26,5	20	25	26,5
IR 20x25x30	20	25	30
IR 20x25x38,5	20	25	38,5
IR 20x28x20	20	28	20
IR 22x26x16	22	26	16
IR 22x26x20	22	26	20
IR 22x28x17	22	28	17
IR 22x28x20,5	22	28	20,5
IR 22x28x30	22	28	30
IR 25x29x20	25	29	20
IR 25x29x30	25	29	30
IR 25x30x16	25	30	16
IR 25x30x17	25	30	17
IR 25x30x20	25	30	20
IR 25x30x20,5	25	30	20,5

Modelo	d mm	F mm	B mm
IR 25x30x26,5	25	30	26,5
IR 25x30x30	25	30	30
IR 25x30x32	25	30	32
IR 25x30x38,5	25	30	38,5
IR 25x32x22	25	32	22
IR 28x32x17	28	32	17
IR 28x32x20	28	32	20
IR 28x32x30	28	32	30
IR 30x35x13	30	35	13
IR 30x35x16	30	35	16
IR 30x35x17	30	35	17
IR 30x35x18	30	35	18
IR 30x35x20	30	35	20
IR 30x35x20,5	30	35	20,5
IR 30x35x26	30	35	26
IR 30x35x30	30	35	30
IR 30x37x22	30	37	22
IR 32x37x30	32	37	30
IR 32x40x20	32	40	20
IR 32x40x36	32	40	36
IR 35x40x17	35	40	17
IR 35x40x20	35	40	20
IR 35x40x20,5	35	40	20,5
IR 35x40x30	35	40	30
IR 35x42x36	35	42	36
IR 40x45x17	40	45	17
IR 40x45x20	40	45	20
IR 40x45x20,5	40	45	20,5
IR 40x45x30	40	45	30
IR 40x48x22	40	48	22
IR 40x48x40	40	48	40
IR 40x50x20	40	50	20
IR 40x50x22	40	50	22



19027

ANILLOS INTERIORES DE RODAMIENTOS DE AGUJAS



SERIE IR...

Modelo	d mm	F mm	B mm
IR 6x9x12	6	8	12
IR 6x10x10	6	10	10
IR 6x10x12	6	10	12
IR 7x10x10,5	7	10	10,5
IR 7x10x12	7	10	12
IR 8x12x10	8	12	10
IR 8x12x10,5	8	12	10,5
IR 8x12x12	8	12	12
IR 8x12x12,5	8	12	12,5
IR 9x12x12	9	12	12
IR 9x12x16	9	12	16
IR 10x13x12,5	10	13	12,5
IR 10x14x12	10	14	12
IR 10x14x13	10	14	13
IR 10x14x14	10	14	14
IR 10x14x16	10	14	16
IR 10x14x20	10	14	20
IR 12x15x12	12	15	12
IR 12x15x12,5	12	15	12,5
IR 12x15x16	12	15	16
IR 12x15x16,5	12	15	16,5
IR 12x15x22,5	12	15	22,5
IR 12x16x12	12	16	12
IR 12x16x13	12	16	13
IR 12x16x14	12	16	14
IR 12x16x16	12	16	16
IR 12x16x20	12	16	20

Modelo	d mm	F mm	B mm
IR 12x16x22	12	16	22
IR 14x17x17	14	17	17
IR 15x18x16	15	18	16
IR 15x18x16,5	15	18	16,5
IR 15x19x20	15	19	20
IR 15x20x13	15	20	13
IR 15x20x14	15	20	14
IR 15x20x23	15	20	23
IR 17x20x16	17	20	16
IR 17x20x16,5	17	20	16,5
IR 17x20x20	17	20	20
IR 17x20x20,5	17	20	20,5
IR 17x20x30,5	17	20	30,5
IR 17x21x20	17	21	20
IR 17x22x13	17	22	13
IR 17x22x16	17	22	16
IR 17x22x23	17	22	23
IR 20x24x16	20	24	16
IR 20x24x20	20	24	20
IR 20x25x16	20	25	16
IR 20x25x17	20	25	17
IR 20x25x20	20	25	20
IR 20x25x20,5	20	25	20,5
IR 20x25x26,5	20	25	26,5
IR 20x25x30	20	25	30
IR 20x25x38,5	20	25	38,5
IR 20x28x20	20	28	20
IR 22x26x16	22	26	16
IR 22x26x20	22	26	20
IR 22x28x17	22	28	17
IR 22x28x20,5	22	28	20,5
IR 22x28x30	22	28	30
IR 25x29x20	25	29	20
IR 25x29x30	25	29	30
IR 25x30x16	25	30	16

Modelo	d mm	F mm	B mm
IR 25x30x17	25	30	17
IR 25x30x20	25	30	20
IR 25x30x20,5	25	30	20,5
IR 25x30x26,5	25	30	26,5
IR 25x30x30	25	30	30
IR 25x30x32	25	30	32
IR 25x30x38,5	25	30	38,5
IR 25x32x22	25	32	22
IR 28x32x17	28	32	17
IR 28x32x20	28	32	20
IR 28x32x30	28	32	30
IR 30x35x13	30	35	13
IR 30x35x16	30	35	16
IR 30x35x17	30	35	17
IR 30x35x18	30	35	18
IR 30x35x20	30	35	20
IR 30x35x20,5	30	35	20,5
IR 30x35x26	30	35	26
IR 30x35x30	30	35	30
IR 30x37x22	30	37	22
IR 32x37x30	32	37	30
IR 32x40x20	32	40	20
IR 32x40x36	32	40	36
IR 35x40x17	35	40	17
IR 35x40x20	35	40	20
IR 35x40x20,5	35	40	20,5
IR 35x40x30	35	40	30
IR 35x42x36	35	42	36
IR 40x45x17	40	45	17
IR 40x45x20	40	45	20
IR 40x45x20,5	40	45	20,5
IR 40x45x30	40	45	30
IR 40x48x22	40	48	22
IR 40x48x40	40	48	40
IR 40x50x20	40	50	20
IR 40x50x22	40	50	22

19028

CASQUILLOS DE AGUJAS



SERIE BK...

Con fondo
Sin obturación

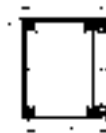

SERIE BK...PS

Con fondo
Obturados

Modelo	Fw mm	D mm	C mm
BK 0306 TN	3	6,5	6
BK 0408	4	8	8
BK 0509	5	9	9
BK 0609	6	10	9
BK 0709	7	11	9
BK 0808	8	12	8
BK 0810	8	12	10
BK 0910	9	13	10
BK 0912	9	13	12
BK 1010	10	14	10
BK 1210	12	16	10
BK 1212	12	18	12
BK 1412	14	20	12
BK 1516	15	21	16
BK 1616	16	22	16
BK 2526	25	32	26
BK 2538	25	32	38

Modelo	Fw mm	D mm	C mm
BK 3038	30	37	38
BK 4020	40	47	20
BK 1414 RS	14	20	14
BK 2018 RS	20	26	18
BK 2518 RS	25	32	18



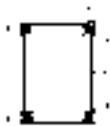

SERIE HK...

Modelo	Fw mm	D mm	C mm
HK 0306	3	6,5	6
HK 0408	4	8	8
HK 0509	5	9	9
HK 0608	6	10	8
HK 0609	6	10	9
HK 0709	7	11	9
HK 0808	8	12	8
HK 0810	8	12	10
HK 0908	9	13	8
HK 0910	9	13	10
HK 0912	9	13	12
HK 1010	10	14	10
HK 1012	10	14	12
HK 1015	10	14	15
HK 1210	12	16	10
HK 1212	12	18	12
HK 1312	13	19	12
HK 1412	14	20	12

Modelo	Fw mm	D mm	C mm
HK 1512	15	21	12
HK 1516	15	21	16
HK 1522	15	21	22
HK 1612	16	22	12
HK 1616	16	22	16
HK 1622	16	22	22
HK 1712	17	23	12
HK 1812	18	24	12
HK 1816	18	24	16
HK 2010	20	26	10
HK 2012	20	26	12
HK 2016	20	26	16
HK 2020	20	26	20
HK 2030	20	26	30
HK 2210	22	28	10
HK 2212	22	28	12
HK 2216	22	28	16
HK 2220	22	28	20

Modelo	Fw mm	D mm	C mm
HK 2512	25	32	12
HK 2516	25	32	16
HK 2520	25	32	20
HK 2526	25	32	26
HK 2538	25	32	38
HK 2816	28	35	16
HK 2820	28	35	20
HK 3012	30	37	12
HK 3016	30	37	16
HK 3020	30	37	20
HK 3026	30	37	26
HK 3038	30	37	38
HK 3512	35	42	12
HK 3516	35	42	16
HK 3520	35	42	20
HK 4012	40	47	12
HK 4016	40	47	16
HK 4020	40	47	20



SERIE HK...RS

Obturados por un lado

Modelo	Fw mm	D mm	C mm
HK 0810 RS	8	12	10
HK 1012 RS	10	14	12
HK 1214 RS	12	18	14
HK 1414 RS	14	20	14
HK 1514 RS	15	21	14
HK 1614 RS	16	22	14
HK 1814 RS	18	24	14
HK 2018 RS	20	26	18
HK 2212 RS	22	28	12
HK 2218 RS	22	28	18
HK 2518 RS	25	32	18
HK 2818 RS	28	35	18
HK 3018 RS	30	37	18
HK 3518 RS	35	42	18
HK 4018 RS	40	47	18



SERIE HK...2RS

Obturados por dos lados

Modelo	Fw mm	D mm	C mm
HK 0812 2RS	8	12	12
HK 1014 2RS	10	14	14
HK 1216 2RS	12	18	16
HK 1416 2RS	14	20	16
HK 1516 2RS	15	21	16
HK 1520 2RS	15	21	20
HK 1616 2RS	16	22	16
HK 1620 2RS	16	22	20
HK 1816 2RS	18	24	16
HK 2016 2RS	20	26	16
HK 2020 2RS	20	26	20
HK 2216 2RS	22	28	16
HK 2220 2RS	22	28	20
HK 2516 2RS	25	32	16
HK 2520 2RS	25	32	20
HK 2514 2RS	25	32	24
HK 2530 2RS	25	32	30
HK 2820 2RS	28	35	20
HK 3016 2RS	30	37	16
HK 3020 2RS	30	37	20
HK 3024 2RS	30	37	24
HK 3516 2RS	35	42	16
HK 3520 2RS	35	42	20
HK 4016 2RS	40	47	16
HK 4020 2RS	40	47	20

19 Rodamientos y cojinetes

Agujas de rodamiento

19029

AGUJAS DE RODAMIENTO

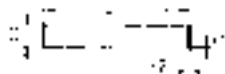

SERIE NRB...

Modelo	Dw mm	Lw mm
NRB 1 x 7,8	1	7,8
NRB 1,5 x 5,8	1,5	5,8
NRB 1,5 x 9,8	1,5	9,8
NRB 2 x 6,3	2	6,8
NRB 2 x 7,8	2	7,8
NRB 2 x 9,8	2	9,8
NRB 2 x 11,8	2	11,8
NRB 2 x 13,8	2	13,8
NRB 2 x 15,8	2	15,8
NRB 2 x 17,8	2	17,8

Modelo	Dw mm	Lw mm
NRB 2,5 x 7,8	2,5	7,8
NRB 2,5 x 9,8	2,5	9,8
NRB 2,5 x 11,8	2,5	11,8
NRB 2,5 x 13,8	2,5	13,8
NRB 2,5 x 15,8	2,5	15,8
NRB 2,5 x 19,8	2,5	19,8
NRB 2,5 x 31,8	2,5	31,8
NRB 2,5 x 23,8	2,5	23,8
NRB 3 x 9,8	3	9,8
NRB 3 x 11,8	3	11,8
NRB 3 x 13,8	3	13,8
NRB 3 x 15,8	3	15,8
NRB 3 x 17,8	3	17,8
NRB 3 x 19,8	3	19,8
NRB 3 x 21,8	3	21,8
NRB 3 x 23,8	3	23,8
NRB 3,5 x 15,8	3,5	15,8

Modelo	Dw mm	Lw mm
NRB 3,5 x 19,8	3,5	19,8
NRB 3,5 x 21,8	3,5	21,8
NRB 3,5 x 29,8	3,5	29,8
NRB 4 x 15,8	4	15,8
NRB 4 x 17,8	4	17,8
NRB 4 x 19,8	4	19,8
NRB 4 x 21,8	4	21,8
NRB 4 x 23,8	4	23,8
NRB 4 x 25,8	4	25,8
NRB 4 x 29,8	4	29,8
NRB 4 x 34,8	4	34,8
NRB 4 x 39,8	4	39,8
NRB 5 x 19,8	5	19,8
NRB 5 x 23,8	5	23,8
NRB 5 x 27,8	5	27,8
NRB 5 x 29,8	5	29,8
NRB 5 x 39,8	5	39,8

19030

ANILLOS OBTURADORES

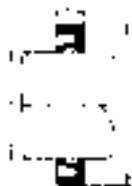

SERIE SD...

Resina de poliéster,
doble labio.

Modelo	d mm	D mm	b mm
SD 10 x 17 x 3	10	40	3
SD 15 x 21 x 3	15	40	3
SD 16 x 24 x 3	16	40	3
SD 18 x 24 x 3	18	40	3
SD 20 x 26 x 4	20	40	4
SD 20 x 28 x 4	20	40	4
SD 25 x 33 x 4	25	40	4
SD 25 x 35 x 4	25	40	4
SD 28 x 35 x 4	28	40	4
SD 30 x 37 x 4	30	40	4

Modelo	d mm	D mm	b mm
SD 30 x 40 x 4	30	40	4
SD 32 x 42 x 4	32	42	4
SD 35 x 42 x 4	35	42	4
SD 35 x 45 x 4	35	45	4
SD 38 x 48 x 4	38	48	4
SD 40 x 47 x 4	40	47	4
SD 40 x 50 x 4	40	50	4
SD 40 x 52 x 5	40	40	5
SD 45 x 52 x 4	45	45	4



SERIE G...

Elastómero NBR
1 sólo labio.

Modelo	d mm	D mm	b mm
SD 8 x 12 x 3	8	12	3
SD 8 x 15 x 3	8	15	3
SD 9 x 13 x 3	8	13	3
SD 10 x 14 x 3	10	14	3
SD 10 x 17 x 3	10	17	3
SD 12 x 16 x 3	12	16	3
SD 12 x 18 x 3	12	18	3
SD 12 x 19 x 3	12	19	3
SD 13 x 19 x 3	13	19	3
SD 14 x 20 x 3	14	20	3
SD 14 x 22 x 3	14	22	3
SD 15 x 21 x 3	15	21	3
SD 15 x 23 x 3	15	23	3
SD 16 x 22 x 3	16	22	3
SD 16 x 24 x 3	16	24	3
SD 18 x 24 x 3	18	24	3
SD 18 x 26 x 4	18	26	4
SD 19 x 27 x 4	19	27	4
SD 20 x 26 x 4	20	26	4
SD 20 x 28 x 4	20	28	4
SD 22 x 28 x 4	22	28	4

Modelo	d mm	D mm	b mm
SD 22 x 30 x 4	22	30	4
SD 24 x 32 x 4	24	32	4
SD 25 x 32 x 4	25	32	4
SD 25 x 33 x 4	25	33	4
SD 25 x 35 x 4	25	35	4
SD 28 x 35 x 4	28	35	4
SD 30 x 37 x 4	30	37	4
SD 30 x 40 x 4	30	40	4
SD 32 x 42 x 4	32	42	4
SD 35 x 42 x 4	35	42	4
SD 35 x 45 x 4	35	45	4
SD 38 x 48 x 4	38	48	4
SD 40 x 47 x 4	40	47	4
SD 40 x 50 x 4	40	50	4
SD 40 x 52 x 4	40	52	4
SD 42 x 52 x 4	42	52	4
SD 45 x 52 x 4	45	52	4
SD 45 x 55 x 4	45	55	4
SD 50 x 58 x 4	50	58	4
SD 50 x 62 x 4	50	62	4
SD 55 x 63 x 4	55	63	4

19031

RODAMIENTOS DE AGUJAS COMBINADOS

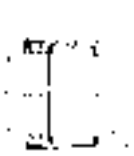

SERIE NX...

Con cubierta protectora
para lubricación por aceite



SERIE NX...Z

Con cubierta protectora
para lubricación por grasa

Modelo	Modelo	Fw mm	D mm	C mm
NX 7 TN	NX 7 Z TN	7	14	18
NX 10	NX 10 Z	10	19	18
NX 12	NX 12 Z	12	21	18
NX 15	NX 15 Z	15	24	28
NX 17	NX 17 Z	17	26	28
NX 20	NX 20 Z	20	30	28
NX 25	NX 25 Z	25	37	30
NX 30	NX 30 Z	30	42	30
NX 35	NX 35 Z	35	47	30

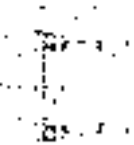

SERIE NKX...



SERIE NKX...Z

Con cubierta de protección

Modelo	Modelo	Fw mm	D mm	C mm
NKX 10	NKX 10 Z	10	19	23
NKX 12	NKX 12 Z	12	21	23
NKX 15	NKX 15 Z	15	24	23
NKX 17	NKX 17 Z	17	26	25
NKX 20	NKX 20 Z	20	30	30
NKX 25	NKX 25 Z	25	37	30
NKX 30	NKX 30 Z	30	42	30
NKX 35	NKX 35 Z	35	47	30
NKX 40	NKX 40 Z	40	52	32
NKX 45	NKX 45 Z	45	58	32
NKX 50	NKX 50 Z	50	62	35
NKX 60	NKX 60 Z	60	72	40
NKX 70	NKX 70 Z	70	85	40



SERIE NKXR...

Sin cubierta de protección



SERIE NKXR...Z

Con cubierta de protección

Modelo	Modelo	Fw mm	D mm	C mm
NKXR 15	NKXR 15 Z	15	24	23
NKXR 17	NKXR 17 Z	17	26	25
NKXR 20	NKXR 20 Z	20	30	30
NKXR 25	NKXR 25 Z	25	37	30
NKXR 30	NKXR 30 Z	30	42	30
NKXR 35	NKXR 35 Z	35	47	30
NKXR 40	NKXR 40 Z	40	52	32
NKXR 45	NKXR 45 Z	45	58	32
NKXR 50	NKXR 50 Z	50	62	35



SERIE NKIA...

Contacto angular
Simple efecto



SERIE NKIB...

Contacto angular
Doble efecto

Modelo	d mm	D mm	B mm
NKIA 5901	12	24	16
NKIA 5902	15	28	18
NKIA 5903	17	30	18
NKIA 5904	20	37	23
NKIA 5905	25	42	23
NKIA 5906	30	47	23
NKIA 5907	35	55	27
NKIA 5908	40	62	30
NKIA 5909	45	68	30
NKIA 5910	50	72	30
NKIA 5912	60	85	34
NKIA 5913	65	90	34
NKIA 5914	70	100	40

Modelo	d mm	D mm	B mm
NKIB 5901	12	24	17,5
NKIB 5902	15	28	20
NKIB 5903	17	30	20
NKIB 5904	20	37	25
NKIB 59/22	22	39	25
NKIB 5905	25	42	25
NKIB 5906	30	47	25
NKIB 5907	35	55	30
NKIB 5908	40	62	34
NKIB 5909	45	68	34
NKIB 5910	50	72	34
NKIB 5911	55	80	38
NKIB 5912	60	85	38
NKIB 5913	65	90	38
NKIB 5914	70	100	45

19032

RODAMIENTOS AXIALES DE AGUJAS



RODAMIENTOS

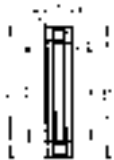

SERIE 811...

Modelo	d mm	D mm	T mm
811 02 TN	15	28	9
811 03 TN	17	30	9
811 04 TN	20	35	10
811 05 TN	25	42	11
811 06 TN	30	47	11
811 07 TN	35	52	12
811 08 TN	40	60	13
811 09 TN	45	65	14
811 10 TN	50	70	14

Modelo	d mm	D mm	T mm
811 11 TN	55	78	16
811 12 TN	60	85	17
811 13 TN	65	90	18
811 14 TN	70	95	18
811 15 TN	75	100	19
811 16 TN	80	105	19
811 17 TN	85	110	19
811 18 TN	90	120	22
811 19 TN	100	135	25



SERIE 812...

Modelo	d mm	D mm	T mm
812 06 TN	30	52	16
812 07 TN	35	62	18
812 08 TN	40	68	19
812 09 TN	45	73	20
812 10 TN	50	78	22
812 11 TN	55	90	25

Modelo	d mm	D mm	T mm
812 12 TN	60	95	26
812 13 TN	65	100	27
812 14 TN	70	105	27
812 15 TN	75	110	27
812 16 TN	80	115	28
812 17 TN	85	125	31
812 18 TN	90	135	35



SERIE AXW...
Con resalte de
centraje en el
disco axial

Modelo	d mm	D mm	T mm
AXW 10	10	14	27
AXW 12	12	16	29
AXW 15	15	21	31
AXW 20	20	26	38
AXW 25	25	32	45

Modelo	d mm	D mm	T mm
AXW 30	30	37	50
AXW 35	35	42	55
AXW 40	40	47	63
AXW 45	45	52	68

CORONAS



SERIE K811...

Modelo	d mm	D mm	T mm
K811 02 TN	15	28	3,5
K811 03 TN	17	30	3,5
K811 04 TN	20	35	4,5
K811 05 TN	25	42	5
K811 06 TN	30	47	5
K811 07 TN	35	52	5
K811 08 TN	40	60	6
K811 09 TN	45	65	6
K811 10 TN	50	70	6

Modelo	d mm	D mm	T mm
K811 11 TN	55	78	6
K811 12 TN	60	85	7,5
K811 13 TN	65	90	7,5
K811 14 TN	70	95	7,5
K811 15 TN	75	100	7,5
K811 16 TN	80	105	7,5
K811 17 TN	85	110	7,5
K811 18 TN	90	120	9
K811 19 TN	100	135	11

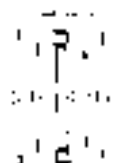

SERIE K812...

Modelo	d mm	D mm	T mm
K812 06 TN	30	52	7,5
K812 07 TN	35	62	7,5
K812 08 TN	40	68	9
K812 09 TN	45	73	9
K812 10 TN	50	78	9
K812 11 TN	55	90	11

Modelo	d mm	D mm	T mm
K812 12 TN	60	95	11
K812 13 TN	65	100	11
K812 14 TN	70	105	11
K812 15 TN	75	110	11
K812 16 TN	80	115	11
K812 17 TN	85	125	12
K812 18 TN	90	135	14



SERIE AXK...

Modelo	d mm	D mm	T mm
AXK 0414	4	14	2
AXK 0515	5	15	2
AXK 0619	6	19	2
AXK 0821	8	21	2
AXK 1024	10	24	2
AXK 1226	12	26	2
AXK 1528	15	28	2
AXK 1730	17	30	2
AXK 2035	20	35	2
AXK 2542	25	42	2
AXK 3047	30	47	2
AXK 3552	35	52	2

Modelo	d mm	D mm	T mm
AXK 4060	40	60	3
AXK 4565	45	65	3
AXK 5070	50	70	3
AXK 5578	55	78	3
AXK 6085	60	85	3
AXK 6590	65	90	3
AXK 7095	70	95	4
AXK 75100	75	100	4
AXK 80105	80	105	4
AXK 85110	85	110	4
AXK 90120	90	120	4
AXK 100135	100	135	4

DISCOS EJE

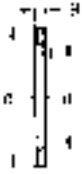

SERIE WS 811... SERIE WS 812...

Modelo	d mm	d1 mm	B mm
811 02 TN	15	28	2,75
811 03 TN	17	30	2,75
811 04 TN	20	35	2,75
811 05 TN	25	42	3
811 06 TN	30	47	3
811 07 TN	35	52	3,5
811 08 TN	40	60	3,5
811 09 TN	45	65	4
811 10 TN	50	70	4

Modelo	d mm	d1 mm	B mm
811 11 TN	55	78	5
811 12 TN	60	85	4,75
811 13 TN	65	90	5,25
811 14 TN	70	95	5,25
811 15 TN	75	100	5,75
811 16 TN	80	105	5,75
811 17 TN	85	110	5,75
811 18 TN	90	120	6,5
811 20 TN	100	135	7

Modelo	d mm	d1 mm	B mm
812 06 TN	30	52	4,25
812 07 TN	35	62	5,25
812 08 TN	40	68	5
812 09 TN	45	73	5,5
812 10 TN	50	78	6,5
812 11 TN	55	90	7

Modelo	d mm	d1 mm	B mm
812 12 TN	60	95	7,5
812 13 TN	65	100	8
812 14 TN	70	105	8
812 15 TN	75	110	8
812 16 TN	80	115	8,5
812 17 TN	85	125	9,5
812 18 TN	90	135	10,5

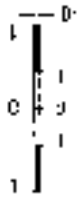

SERIE AS...

Modelo	d mm	D mm	B1 mm
AS 0414	4	14	1
AS 0515	5	15	1
AS 0619	6	19	1
AS 0821	8	21	1
AS 1024	10	24	1
AS 1226	12	26	1
AS 1528	15	28	1
AS 1730	17	30	1
AS 2035	20	35	1
AS 2542	25	42	1
AS 3047	30	47	1
AS 3552	35	52	1

Modelo	d mm	D mm	B1 mm
AS 4060	40	60	1
AS 4565	45	65	1
AS 5070	50	70	1
AS 5578	55	78	1
AS 6085	60	85	1
AS 6590	65	90	1
AS 7095	70	95	1
AS 75100	75	100	1
AS 80105	80	105	1
AS 85110	85	110	1
AS 90120	90	120	1
AS 100135	100	135	1

DISCOS DE RODADURA AXIAL



SERIE LS...

Modelo	d mm	D mm	B mm
LS 0619	6	19	2,75
LS 0821	8	21	2,75
LS 1024	10	24	2,75
LS 1226	12	26	2,75
LS 1528	15	28	2,75
LS 1730	17	30	2,75
LS 2035	20	35	2,75

Modelo	d mm	D mm	B mm
LS 2542	25	42	3
LS 3047	30	47	3
LS 3552	35	52	3,5
LS 4060	40	60	3,5
LS 4565	45	65	4
LS 5070	50	70	4

DISCOS ALOJAMIENTO

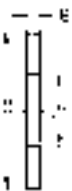

SERIE GS 811... SERIE GS 812...

Modelo	d mm	d1 mm	B mm
GS 811 02	15	28	2,75
GS 811 03	17	30	2,75
GS 811 04	20	35	2,75
GS 811 05	25	42	3
GS 811 06	30	47	3
GS 811 07	35	52	3,5
GS 811 08	40	60	3,5
GS 811 09	45	65	4
GS 811 10	50	70	4

Modelo	d mm	d1 mm	B mm
GS 811 11	55	78	5
GS 811 12	60	85	4,75
GS 811 13	65	90	5,25
GS 811 14	70	95	5,25
GS 811 15	75	100	5,75
GS 811 16	80	105	5,75
GS 811 17	85	110	5,75
GS 811 18	90	120	6,5
GS 811 20	100	135	7

Modelo	d mm	d1 mm	B mm
GS 812 06	30	52	4,25
GS 812 07	35	62	5,25
GS 812 08	40	68	5
GS 812 09	45	73	5,5
GS 812 10	50	78	6,5
GS 812 11	55	90	7

Modelo	d mm	d1 mm	B mm
GS 812 12	60	95	7,5
GS 812 13	65	100	8
GS 812 14	70	105	8
GS 812 15	75	110	8
GS 812 16	80	115	8,5
GS 812 17	85	125	9,5
GS 812 18	90	135	10,5

19033

SISTEMAS DE GUIADO LINEAL



GUIAS LINEALES CON CARRIL GUIA



RUE..D
RUE..D L
RUE..D H
RUE..D
HL



KUSE
KUSE..L
KUSE..H
KUSE..LH



KUVE
KUVE..L
KUVE..H
KUVE..S
KUVE..SN

KUVE..N
KUVE..W
KUVE..WL
KUVE..E
KUVE..E S

KUVE..E C
KUVE..E SC
KUVE..K



KUVS
KWVK..AL



KUE
KUE..H



KA..TN
KA..M



KA..MM



KA..TN A

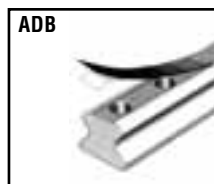

ADB

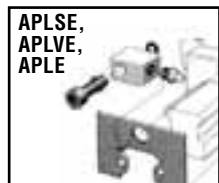

APLSE,
APLVE,
APLE



APLU..D



AB KOL
KWSE

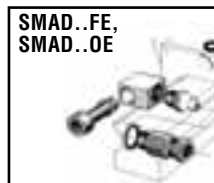

SMAD..FE,
SMAD..OE

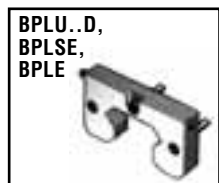

BPLU..D,
BPLSE,
BPLE



SMDE

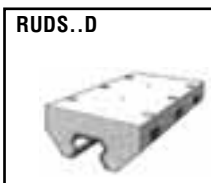

RUDS..D



RUKS..D



FBALG

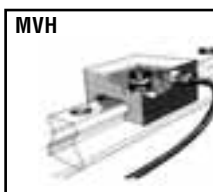

MVH

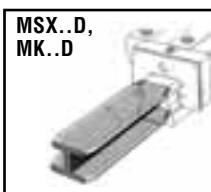

MSX..D,
MK..D

PARA MAS DATOS TECNICOS DE ESTOS PRODUCTOS PONEMOS A DISPOSICION DE NUESTROS CLIENTES UN CATALOGO ESPECIFICO DE LOS MISMOS

GUIAS LINEALES CON RODILLOS GUIA



LFL..B



LFL..SF, LFL..C



LFKL..SF



LFCL, LFS..C



LFDL, LFS..R

LFS



LFS..C



LFS..F



LFS..N



LFS..NZZ



LFS..ZZ



LFS..M



LFS..CH



LFS..FH



LFS..R



TSNW



TSNW..G4
TSNW..G5



TSUW



TSSW



TSMW



LFR, LFZ,
LFE



AB LFR,
AB LFL



AB, ABW



19033

SISTEMAS DE GUIADO LINEAL

SISTEMAS DE GUIADO POR EJE

